

The Garador Range Price List

Up & Over Doors, Sectional Doors, Side-hinged Doors and Operators



January 2009

GARADOR
The Garage Door People

Contents

General Information for Canopy and Retractable Doors . . .	3
Steel Panel Doors	4
Steel Side-hinged Doors	8
PVC Panel Doors	9
GRP Premier Panel Doors	10
Timber Panel Doors	14
Frame Dimensions	18
Canopy Gear Specifications	19
Single & Double Retractable Gear Specifications	20
Side-hinged Door Specifications	21
General Information for Sectional Doors	23
Steel Sectional Doors	24
Sectional Door Specifications	28
Electric Operators	30
Accessories for Electric Operators	31
Operator Specifications	32
Care	33
Warranty	34
Extracts from AGDS consumer advice	35



Please ensure that you order the correct size door to fit your opening as we are unable to accept the return of incorrectly ordered goods. Please contact Garador on 01935 443722 if you need assistance in calculating the correct size.

A comprehensive range of the more popular spares is available. Please ask for spares price list.

All prices in £.

Since the company's policy is one of continuous improvement of its products, we reserve the right to make any alterations in design, manufacture or price. All business is governed by the Company's Standard Conditions and this document does not form any part of any contract with the company and statements contained in it should not be construed as representations or warranties.

General Information for Canopy and Retractable Doors

STEEL

Surface:	High quality powder or foil coated finish.
Stock availability:	Prices in bold show stock doors on a one-week lead-time. All other prices are non-stock standard doors on a two-week lead-time. Brown finish doors in all styles (except Beaumont with windows) in 7066 and 7070 sizes only are available ex-stock. All other sizes in brown are non-stock doors.
Colours:	White (RAL 9016) and Brown (RAL 8028) as standard, other optional colours are available on a 3 week lead-time. The Wentwood and Sherwood are available in Golden Oak and Rosewood with a chassis colour to match.
Handle:	Black handle as standard, optional handles are available. Doors can be supplied undrilled and without handle and locking mechanism for use with electric operator (not available Wentwood or Sherwood), please specify with order.
Packaging:	White and brown doors are supplied unwrapped as standard, optional poly-wrapping is available. Optional coloured doors are supplied wrapped and include a touch up stick as standard. Side-hinged doors are provided wrapped as standard.
Warranty:	For details see page 34.

GRP

Surface:	High gloss or woodgrain finish depending on door style. GRP Premier doors are constructed as an infill panel and are fixed into a rigid box section chassis. This chassis is White (RAL 9016) for Gloss White and Brown (RAL 8028) on all other timber effect doors. The infill has a flow coat to the inside face for a smoother finish and reduced translucency. Doors without flow coat are available.
Stock availability:	All GRP doors are made to order and thus require a lead-time of 4 weeks.
Colours:	Ashurst, Arden and Stamford are available in Gloss White finish only. All other doors are available in a range of woodgrain colours. Due to the production processes door colours may vary. Should you require matching doors please specify on your order.
Handle:	Black handle and base plate as standard, optional handles available. Doors can be supplied undrilled and without handle and locking mechanism for use with electric operator. This must be requested at the time of order.
Packaging:	Supplied with front surface protection as standard.
Warranty:	For details see page 34.

TIMBER

Surface:	All timber doors are supplied untreated and require immediate on-site finishing. Timber is a natural material and therefore Garador cannot guarantee to be able to produce matching timber garage doors.
Stock availability:	Timber doors are generally made to order and thus require a lead-time of 4 weeks. Limited styles and sizes are held for ex-stock delivery.
Handle:	Black handle and base plate as standard, optional handles available. Doors can be supplied undrilled and without handle and locking mechanism for use with electric operator.
Packaging:	Supplied with front surface protection as standard.
Warranty:	For details see page 34.

GEARS



Canopy gear (C)
for single doors

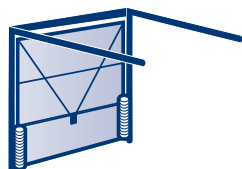

Retractable gear (R)
for single and double doors

Please note:

Panel doors are produced with appearance in mind. This may result in some small gaps which could allow water ingress especially in exposed locations.

OPERATORS

GaraMatic operators are an ideal match for all current Garador up & over and sectional doors. As a tried and tested unit hardware on both the door and the operator are perfectly matched and prepared for easy installation.



Timber-effect doors ✓

Single door

Size Code	Internal Timber frame opening Width x Height (mm x mm)	GEORGIAN		BEAUMONT		BEAUMONT with windows ¹		CATHEDRAL		CARLTON		SALISBURY		HORIZON		CHEVRON		WENTWOOD		SHERWOOD	
		C	R	C	R	C	R	C	R	C	R	C	R	C	R	C	R	C	R	C	R
6660	1984 x 1830	-	-	-	-	-	-	-	-	-	-	-	-	425	-	-	-	-	-	-	-
6663	1984 x 1905	-	-	-	-	-	-	-	-	-	-	-	-	425	-	-	-	-	-	-	-
6664	1984 x 1931	594	633	594	633	810	849	594	633	486	525	-	-	425	464	-	-	-	-	-	-
6666	1984 x 1981	563	602	563	602	779	818	563	602	462	501	-	-	403	442	480	519	-	-	-	-
6670	1984 x 2136	573	612	573	612	789	828	573	612	462	501	-	-	403	442	480	519	-	-	-	-
61064	2084 x 1931	570	609	570	609	786	825	570	609	461	499	-	-	412	451	-	-	-	-	-	-
61066	2084 x 1981	571	610	571	610	787	826	571	610	461	499	-	-	421	459	-	-	-	-	-	-
61070	2084 x 2136	612	651	612	651	828	867	612	651	471	510	-	-	437	476	-	-	-	-	-	-
7060	2134 x 1830	-	-	-	-	-	-	-	-	-	-	-	-	438	-	-	-	-	-	-	-
7063	2134 x 1905	-	-	-	-	-	-	-	-	-	-	-	-	438	-	-	-	-	-	-	-
7064	2134 x 1931	571	610	571	610	787	826	571	610	463	502	819	821	416	455	507	546	-	-	-	-
7066	2134 x 1981	571	610	571	610	787	826	571	610	449	488	775	814	368	407	480	519	500	539	580	519
7070	2134 x 2136	604	643	604	643	820	859	604	643	467	506	782	821	422	461	512	551	555	594	597	636
7076	2134 x 2286	-	720	-	720	-	936	-	720	-	580	-	-	-	539	-	-	-	-	-	-
7164	2170 x 1931	601	640	601	640	817	856	601	640	496	535	-	-	456	495	-	-	-	-	-	-
7166	2170 x 1981	607	646	607	646	823	862	607	646	498	537	-	-	459	498	-	-	-	-	-	-
7170	2170 x 2136	653	692	653	692	869	908	653	692	520	559	-	-	468	507	-	-	-	-	-	-
7176	2170 x 2286	-	779	-	779	-	995	-	779	-	630	-	-	-	-	-	-	-	-	-	-
7364	2224 x 1931	634	673	634	673	850	889	634	673	485	524	-	-	453	492	-	-	-	-	-	-
7366	2224 x 1981	638	677	638	677	854	893	638	677	488	526	-	-	456	495	-	-	-	-	-	-
7370	2224 x 2136	642	681	642	681	858	897	642	681	494	533	-	-	462	501	-	-	-	-	-	-
7564	2259 x 1931	670	709	670	709	886	925	670	709	512	551	843	882	478	517	556	594	-	-	-	-
7566	2259 x 1981	634	673	634	673	850	889	634	673	491	530	843	882	453	492	556	594	569	608	619	658
7570	2259 x 2136	732	771	732	771	948	987	732	771	553	592	847	886	518	557	613	652	633	672	667	706
7576	2259 x 2286	-	888	-	888	-	1104	-	888	-	630	-	-	-	642	-	-	-	-	-	-
7664	2284 x 1931	634	673	634	673	850	889	634	673	503	542	847	886	453	492	562	601	-	-	-	-
7666	2284 x 1981	634	673	634	673	850	889	634	673	503	542	803	842	453	492	535	574	569	608	619	658
7670	2284 x 2136	732	771	732	771	948	987	732	771	553	592	803	842	519	558	589	628	633	672	667	706
7676	2284 x 2286	-	888	-	888	-	1104	-	888	-	630	-	-	-	646	-	-	-	-	-	-
8064	2439 x 1931	753	792	753	792	969	1008	753	792	597	636	853	891	523	562	-	-	-	-	-	-
8066	2439 x 1981	753	792	753	792	969	1008	753	792	597	636	853	891	523	562	-	-	628	667	713	752
8070	2439 x 2136	783	822	783	822	999	1038	783	822	618	657	854	893	535	574	-	-	651	690	734	773
8076	2439 x 2286	-	954	-	954	-	1170	-	954	-	710	-	-	-	629	-	-	-	-	-	-
8666	2590 x 1981	-	888	-	888	-	1104	-	888	-	685	-	-	-	605	-	-	-	-	-	-
8670	2590 x 2136	-	903	-	903	-	1119	-	903	-	742	-	-	-	626	-	-	-	-	-	-
8676	2590 x 2286	-	1035	-	1035	-	1251	-	1035	-	817	-	-	-	692	-	-	-	-	-	-
9066	2744 x 1981	-	997	-	997	-	1213	-	997	-	791	-	-	-	754	-	-	-	-	-	-
9070	2744 x 2136	-	1015	-	1015	-	1231	-	1015	-	864	-	-	-	791	-	-	-	-	-	-
9076	2744 x 2286	-	1107	-	1107	-	1323	-	1107	-	988	-	-	-	835	-	-	-	-	-	-
1066	3049 x 1981	-	1137	-	1137	-	1461	-	1137	-	958	-	-	-	945	-	-	-	-	-	-
1070	3049 x 2136	-	1160	-	1160	-	1484	-	1160	-	958	-	-	-	945	-	-	-	-	-	-

C = Canopy gear, R = Retractable gear. Prices in bold show stock doors on a one-week lead-time. All other prices are non-stock standard doors on a two-week lead-time.

¹ Windows for Beaumont: Standard (□), Diamond (◊), Cross (⊕). Please state on order if clear or crystal panes.

² Coloured Beaumont with windows & Salisbury doors are supplied with white or brown window frames only.

Steel panel doors - single door options:

For powder-coated doors: Brown (RAL 8028) ²	add £ 25
For powder-coated doors: Blue (RAL 5005) ² , Dark blue (RAL 5011) ² , Green (RAL 6005) ² , Red (RAL 3003) ² , Black (RAL 9005) ²	add £ 90
Retractable plus gear available on 1931, 1981 and 2136 mm high doors up to 2284 mm wide	add £ 27
Factory pre-framed single doors	add £ 90
Diecast metal handles: brass effect, chrome effect and white	add £ 32
Poly-wrapping (free of charge on coloured doors)	add £ 14
Bottom weatherseal, 2405 mm length (suitable for gaps up to 15 mm between the door and the floor level)	add £ 25
Bottom weatherseal, 3000 mm length (suitable for gaps up to 15 mm between the door and the floor level)	add £ 29
Additional Lock Kit, C-type/ R-type (will be fitted onto door if ordered at the same time)	add £ 42

Single door

Internal Timber frame opening
Width x Height
(mm x mm)



GEORGIAN



BEAUMONT



BEAUMONT
with windows¹



CATHEDRAL



CARLTON



HORIZON

		GEORGIAN		BEAUMONT		BEAUMONT with windows ¹		CATHEDRAL		CARLTON		HORIZON	
		C	R	C	R	C	R	C	R	C	R	C	R
1830-1930	x 1830-1930	-	-	-	-	-	-	-	-	-	-	-	-
1830-1930	x 1931-1981	-	-	-	-	-	-	-	-	-	640	-	618
1830-1930	x 1982-2136	-	-	-	-	-	-	-	-	-	675	-	661
1830-1930	x 2137-2286	-	-	-	-	-	-	-	-	-	724	-	701
1830-1930	x 2287-2439	-	-	-	-	-	-	-	-	-	772	-	752
1931-1984	x 1830-1930	-	-	-	-	-	-	-	-	-	-	562	-
1931-1984	x 1931-1981	-	-	-	-	-	-	-	-	606	645	583	622
1931-1984	x 1982-2136	-	-	-	-	-	-	-	-	640	679	618	657
1931-1984	x 2137-2286	-	-	-	-	-	-	-	-	-	724	-	701
1931-1984	x 2287-2439	-	-	-	-	-	-	-	-	-	772	-	752
1985-2134	x 1830-1930	-	-	-	-	-	-	-	-	-	-	583	-
1985-2134	x 1931-1981	787	826	787	826	1016	1055	787	826	640	679	618	657
1985-2134	x 1982-2136	842	881	842	881	1071	1110	842	881	681	720	668	707
1985-2134	x 2137-2286	-	934	-	934	-	1163	-	934	-	772	-	752
1985-2134	x 2287-2439	-	992	-	992	-	1221	-	992	-	815	-	800
2135-2284	x 1830-1930	-	-	-	-	-	-	-	-	-	-	618	-
2135-2284	x 1931-1981	842	881	842	881	1071	1110	842	881	681	720	668	707
2135-2284	x 1982-2136	842	881	842	881	1071	1110	842	881	732	771	710	749
2135-2284	x 2137-2286	-	992	-	992	-	1221	-	992	-	815	-	800
2135-2284	x 2287-2439	-	1059	-	1059	-	1288	-	1059	-	871	-	851
2285-2499	x 1830-1930	-	-	-	-	-	-	-	-	-	-	668	-
2285-2499	x 1931-1981	892	931	892	931	1121	1160	892	931	732	771	710	749
2285-2499	x 1982-2136	949	988	949	988	1178	1217	949	988	772	811	716	755
2285-2499	x 2137-2286	-	1059	-	1059	-	1288	-	1059	-	871	-	851
2285-2499	x 2287-2439	-	1166	-	1166	-	1395	-	1166	-	934	-	907
2500-2590	x 1830-1930	-	-	-	-	-	-	-	-	-	-	-	-
2500-2590	x 1931-1981	-	991	-	991	-	1219	-	991	-	815	-	800
2500-2590	x 1982-2136	-	1059	-	1059	-	1288	-	1059	-	871	-	851
2500-2590	x 2137-2286	-	1166	-	1166	-	1395	-	1166	-	934	-	907
2500-2590	x 2287-2439	-	1293	-	1293	-	1522	-	1293	-	982	-	962
2591-2744	x 1830-1930	-	-	-	-	-	-	-	-	-	-	-	-
2591-2744	x 1931-1981	-	1110	-	1110	-	1339	-	1110	-	934	-	851
2591-2744	x 1982-2136	-	1166	-	1166	-	1395	-	1166	-	1018	-	907
2591-2744	x 2137-2286	-	1293	-	1293	-	1522	-	1293	-	1088	-	962
2591-2744	x 2287-2439	-	-	-	-	-	-	-	-	-	1166	-	1026
2745-3049	x 1830-1930	-	-	-	-	-	-	-	-	-	-	-	-
2745-3049	x 1931-1981	-	1257	-	1257	-	1600	-	1257	-	1088	-	-
2745-3049	x 1982-2136	-	1293	-	1293	-	1636	-	1293	-	1116	-	-

C = Canopy gear, R = Retractable gear. Prices in bold show stock doors on a one-week lead-time. All other prices are non-stock standard doors on a two-week lead-time.

¹ Windows for Beaumont: Standard (□), Diamond (◊), Cross (⊕). Please state on order if clear or crystal panes.

² Coloured Beaumont with windows doors are supplied with white or brown window frames only.

Please note that doors with windows may have cross bracing or locking rods passing behind the windows depending upon size and gear type.

Steel panel doors - single door options:

For powder-coated doors: Brown (RAL 8028)² add £ 25

For powder-coated doors: Blue (RAL 5005)², Dark blue (RAL 5011)², Green (RAL 6005)², Red (RAL 3003)², Black (RAL 9005)² add £ 90

Retractable plus gear available on 1931, 1981 and 2136 mm high doors up to 2284 mm wide add £ 27

Factory pre-framed purpose-made doors

(available as framed canopy in all applicable sizes and as framed retractable only in standard heights) add £ 90

Diecast metal handles: brass effect, chrome effect and white add £ 32





Poly-wrapping (free of charge on coloured doors) add £ 14

Bottom weatherseal, 2405 mm length (suitable for gaps up to 15 mm between the door and the floor level) add £ 25

Bottom weatherseal, 3000 mm length (suitable for gaps up to 15 mm between the door and the floor level) add £ 29

Additional Lock Kit, C-type/ R-type (will be fitted onto door if ordered at the same time) add £ 42

Double door

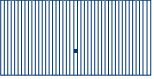
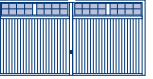
Size Code	Internal Timber frame opening Width x Height (mm x mm)						
		GEORGIAN	BEAUMONT	BEAUMONT with windows ¹	CATHEDRAL	CARLTON	SALISBURY
		R	R	R	R	R	R
1076	3049 x 2286	1449	1449	1773	1449	1348	-
1166	3354 x 1981	1346	1346	1670	1346	1222	-
1170	3354 x 2136	1374	1374	1698	1374	1285	-
1176	3354 x 2286	1539	1539	1863	1539	1431	-
1266	3659 x 1981	1462	1462	1786	1462	1301	-
1270	3659 x 2136	1490	1490	1814	1490	1358	-
1276	3659 x 2286	1672	1672	1996	1672	1515	-
1366	3964 x 1981	1597	1597	2029	1597	1373	-
1370	3964 x 2136	1615	1615	2047	1615	1424	-
1376	3964 x 2286	1787	1787	2219	1787	1584	-
1466	4269 x 1981	1579	1579	2011	1579	1275	2068
1470	4269 x 2136	1579	1579	2011	1579	1275	2068
1566	4574 x 1981	1929	1929	2469	1929	1544	-
1570	4574 x 2136	1973	1973	2513	1973	1583	-
1666	4879 x 1981	2065	2065	2605	2065	1713	-
1670	4879 x 2136	2096	2096	2636	2096	1757	-

R = Retractable gear

Double door

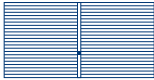
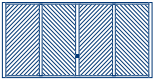
Size Code	Internal Timber frame opening Width x Height (mm x mm)		
		HORIZON	CHEVRON
		R	R
1076	3049 x 2286	1323	-
1166	3354 x 1981	1201	-
1170	3354 x 2136	1265	-
1176	3354 x 2286	1408	-
1266	3659 x 1981	1281	-
1270	3659 x 2136	1338	-
1276	3659 x 2286	1489	-
1366	3964 x 1981	1352	-
1370	3964 x 2136	1399	-
1376	3964 x 2286	1558	-
1466	4269 x 1981	1259	1625
1470	4269 x 2136	1259	1625
1566	4574 x 1981	1509	-
1570	4574 x 2136	1534	-
1666	4879 x 1981	1608	-
1670	4879 x 2136	1657	-

R = Retractable gear. Prices in bold show stock doors on a one-week lead-time. All other prices are non-stock standard doors on a two-week lead-time.

¹ Windows for Beaumont: Standard () , Diamond () , Cross () . Please state on order if clear or crystal panes.

² Coloured Beaumont with windows & Salisbury doors are supplied with white or brown window frames only.

Please note that doors with windows may have cross bracing or locking rods passing behind the windows depending upon size and gear type.

Steel panel doors - double door options:

For powder-coated doors: Brown (RAL 8028) ²	add £ 50
For powder-coated doors: Blue (RAL 5005) ² , Dark blue (RAL 5011) ² , Green (RAL 6005) ² , Red (RAL 3003) ² , Black (RAL 9005) ²	add £ 135
Factory-produced steel frame kits for double door (available for 1981 mm and 2136 mm high doors only)	add £ 145
Diecast metal handles: brass effect, chrome effect and white	add £ 32
Poly-wrapping (free of charge on coloured doors)	add £ 28
Bottom weatherseal, 2405 mm length (suitable for gaps up to 15 mm between the door and the floor level)	add £ 25
Bottom weatherseal, 3000 mm length (suitable for gaps up to 15 mm between the door and the floor level)	add £ 29

Double door

Internal Timber
frame opening
Width x Height
(mm x mm)



GEORGIAN



BEAUMONT



BEAUMONT
with windows¹



CATHEDRAL

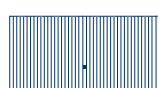

CARLTON



HORIZON

	R	R	R	R	R	R
2745-3049 x 2137-2286	1811	1811	2154	1811	1510	-
2745-3049 x 2287-2439	-	-	-	-	-	-
3050-3354 x 1830-1931	-	-	-	-	-	-
3050-3354 x 1932-1981	1670	1670	2013	1670	1390	1355
3050-3354 x 1982-2136	1811	1811	2154	1811	1510	1468
3050-3354 x 2137-2286	1943	1943	2287	1943	1510	1586
3050-3354 x 2287-2439	-	-	-	-	-	-
3355-3659 x 1830-1931	-	-	-	-	-	-
3355-3659 x 1932-1981	1811	1811	2154	1811	1510	1468
3355-3659 x 1982-2136	1943	1943	2287	1943	1510	1586
3355-3659 x 2137-2286	2112	2112	2455	2112	1510	1712
3355-3659 x 2287-2439	-	-	-	-	-	-
3660-3967 x 1830-1931	-	-	-	-	-	-
3660-3967 x 1932-1981	1943	1943	2287	1943	1621	1586
3660-3967 x 1982-2136	2112	2112	2455	2112	1755	1712
3660-3967 x 2137-2286	2273	2273	2617	2273	1895	1846
3660-3967 x 2287-2439	-	-	-	-	-	-
3968-4269 x 1830-1931	-	-	-	-	-	-
3968-4269 x 1932-1981	2112	2112	2570	2112	1755	1712
3968-4269 x 1982-2136	2273	2273	2731	2273	1895	1846
3968-4269 x 2137-2286	-	-	-	-	-	-
3968-4269 x 2287-2439	-	-	-	-	-	-
4270-5000 x 1932-1981	2216	2216	2788	2216	1901	1863
4270-5000 x 1982-2136	2380	2380	2953	2380	1981	1940

R = Retractable gear. Prices in bold show stock doors on a one-week lead-time. All other prices are non-stock standard doors on a two-week lead-time.

¹ Windows for Beaumont: Standard (□), Diamond (◊), Cross (⊕). Please state on order if clear or crystal panes.

² Coloured Beaumont with windows doors are supplied with white or brown window frames only.

Please note that doors with windows may have cross bracing or locking rods passing behind the windows depending upon size and gear type.

Steel panel doors - double door options:

For powder-coated doors: Brown (RAL 8028)² add £ 50

For powder-coated doors: Blue (RAL 5005)², Dark blue (RAL 5011)², Green (RAL 6005)², Red (RAL 3003)², Black (RAL 9005)² add £ 135

Factory-produced steel frame kits for double door (available for 1981 mm and 2136 mm high doors only) add £ 145

Diecast metal handles: brass effect, chrome effect and white add £ 32

Poly-wrapping (free of charge on coloured doors) add £ 28





Bottom weatherseal, 2405 mm length (suitable for gaps up to 15 mm between the door and the floor level) add £ 25

Bottom weatherseal, 3000 mm length (suitable for gaps up to 15 mm between the door and the floor level) add £ 29

Standard side-hinged door

Size Code	Internal frame opening Width x Height (mm x mm)	Overall frame size (between fix) ¹					
			GEORGIAN	BEAUMONT	BEAUMONT with windows ²	CATHEDRAL	CARLTON
6060	1810 x 1830	1930 x 1890	-	-	-	-	771
6660	1964 x 1830	2084 x 1890	-	-	-	-	786
6664	1964 x 1931	2084 x 1991	-	-	-	-	802
6666	1964 x 1981	2084 x 2041	-	-	-	-	802
6670	1964 x 2136	2084 x 2196	-	-	-	-	820
7060	2114 x 1830	2234 x 1890	-	-	-	-	820
7064	2114 x 1931	2234 x 1991	900	900	1116	900	836
7066	2114 x 1981	2234 x 2041	900	900	1116	900	836
7070	2114 x 2136	2234 x 2196	916	916	1132	916	853
7564	2239 x 1931	2359 x 1991	950	950	1166	950	886
7566	2239 x 1981	2359 x 2041	950	950	1166	950	886
7570	2239 x 2136	2359 x 2196	967	967	1183	967	900
7664	2264 x 1931	2384 x 1991	967	967	1183	967	900
7666	2264 x 1981	2384 x 2041	967	967	1183	967	900
7670	2264 x 2136	2384 x 2196	982	982	1198	982	916
8064	2419 x 1931	2539 x 1991	1016	1016	1232	1016	950
8066	2419 x 1981	2539 x 2041	1016	1016	1232	1016	950
8070	2419 x 2136	2539 x 2196	1032	1032	1248	1032	967

Purpose-made side-hinged door

Overall frame size (between fix) ¹ Width x Height (mm x mm)					
	GEORGIAN	BEAUMONT	BEAUMONT with windows ²	CATHEDRAL	CARLTON
1930 - 2234 x 1890 - 2041	-	-	-	-	895
1930 - 2234 x 2042 - 2196	-	-	-	-	921
2235 - 2384 x 1890 - 2041	-	-	-	-	934
2235 - 2384 x 1991 - 2041	1024	1024	1240	1024	967
2235 - 2384 x 2042 - 2196	1036	1036	1252	1036	988
2385 - 2539 x 1890 - 2041	-	-	-	-	980
2385 - 2539 x 1991 - 2041	1088	1088	1304	1088	1023
2385 - 2539 x 2042 - 2196	1104	1104	1320	1104	1037

¹ No fitting clearance allowed.

² Windows for Beaumont: Standard () , Diamond () , Cross () . Please state on order if clear or crystal panes.

³ Coloured Beaumont with windows doors are supplied with white or brown window frames only.

All doors come factory pre-framed, right hand door leaf leading as standard (viewed from the outside).

All side-hinged doors are poly-wrapped as standard.

Steel side-hinged doors - door options:

For powder-coated doors: Brown (RAL 8028) ³	add £ 25
For powder-coated doors: Blue (RAL 5005) ³ , Dark blue (RAL 5011) ³ , Green (RAL 6005) ³ , Red (RAL 3003) ³ , Black (RAL 9005) ³	add £ 90
Door stays (pair)	add £ 55
Handles: Lever/lever black plastic	add £ 20
Anodised Aluminium lever/lever handles: brass effect and white	add £ 90
Anodised Aluminium lever/lever handles: chrome effect	add £ 115
Left hand leaf leading	add £ 50

PVC Panel Doors

NEW ✓



SHERBORNE

Single door

Size Code	Internal Timber frame opening Width x Height (mm x mm)		
		C	R
7066	2134 x 1981	696	735
7070	2134 x 2136	696	735
7566	2259 x 1981	752	791
7570	2259 x 2136	752	791
7666	2284 x 1981	758	797
7670	2284 x 2136	758	797
8066	2439 x 1981	819	858
8070	2439 x 2136	819	858

PVC panel doors - single door options:

Retractable plus gear available on doors up to 2284 mm wide	add £ 27
Factory pre-framed single door finished in white to match door chassis	add £ 90
Diecast metal handles: brass effect, chrome effect and white	add £ 32
Poly-wrapping	add £ 14
Bottom weatherseal, 2405 mm length (suitable for gaps up to 15 mm between the door and the floor level)	add £ 25
Bottom weatherseal, 3000 mm length (suitable for gaps up to 15 mm between the door and the floor level)	add £ 29
Additional Lock Kit, C-type / R-type (will be fitted onto door if ordered at the same time)	add £ 42

Single door

Size Code	Internal Timber frame opening Width x Height (mm x mm)	STAMFORD		ARDEN		ASHURST		KENMORE		HAZELBURY		PENSURST		HARTFIELD ¹		LINGFIELD		DERWENT		SWINTON	
		C	R	C	R	C	R	C	R	C	R	C	R	C	R	C	R	C	R	C	R
7066	2134 x 1981	1328	1367	1265	1304	1265	1304	1292	1331	1477	1516	1371	1410	1371	1410	1371	1410	1516	1555	1371	1410
7070	2134 x 2136	1328	1367	1265	1304	1265	1304	1292	1331	1477	1516	1371	1410	1371	1410	1371	1410	1516	1555	1371	1410
7566	2259 x 1981	1384	1423	1323	1362	1323	1362	1359	1398	1559	1598	1479	1518	1479	1518	1479	1518	1622	1661	1479	1518
7570	2259 x 2136	1384	1423	1323	1362	1323	1362	1359	1398	1559	1598	1479	1518	1479	1518	1479	1518	1622	1661	1479	1518
7666	2284 x 1981	1399	1438	1335	1374	1335	1374	1371	1410	1571	1610	1491	1530	1491	1530	1491	1530	1637	1676	1491	1530
7670	2284 x 2136	1399	1438	1335	1374	1335	1374	1371	1410	1571	1610	1491	1530	1491	1530	1491	1530	1637	1676	1491	1530
8066	2439 x 1981	1514	1553	1457	1496	1457	1496	1474	1513	1675	1714	1588	1627	1588	1627	1588	1627	1732	1771	1588	1627
8070	2439 x 2136	1514	1553	1457	1496	1457	1496	1474	1513	1675	1714	1588	1627	1588	1627	1588	1627	1732	1771	1588	1627
9066	2744 x 1981	-	1680*	-	1628*	-	1628*	-	1665*	-	-	-	-	-	-	-	-	-	-	-	-
9070	2744 x 2136	-	1680*	-	1628*	-	1628*	-	1665*	-	-	-	-	-	-	-	-	-	-	-	-
1066	3049 x 1981	-	1866*	-	1788*	-	1788*	-	1844*	-	-	-	1956	-	-	-	1956	-	-	-	-
1070	3049 x 2136	-	1866*	-	1788*	-	1788*	-	1844*	-	-	-	1956	-	-	-	1956	-	-	-	-

C = Canopy gear, R = Retractable gear

¹ Hartfield doors not available in matt white colour option.

Please note that doors with windows may have cross bracing or locking rods passing behind the windows depending upon size and gear type.

* Doors only available with electric operation (Handle and Locking not available).

GRP Window options

(for standard and purpose-made single doors)

	STAMFORD	ARDEN	ASHURST	KENMORE	HAZELBURY	Additional Cost (Width mm)		DERWENT
						up to 2743	2744-3049	
Semi-translucent, no leading	A	A	A	A	A	129	192	no on-cost
Semi-translucent, diamond leading	-	B	B	B	B	215	319	Add £ 83
Semi-translucent, square leading	-	C	C	C	C	215	319	Add £ 83
Smoked, no leading	D	D	-	D	D	129	192	no on-cost
Smoked, diamond leading	-	E	-	E	E	215	319	Add £ 83
Smoked, square leading	-	F	-	F	F	215	319	Add £ 83
Imitation black, sunrise	G	-	-	-	-	30	47	-
Imitation black, no leading	-	H	H	H	H	129	192	no on-cost
Imitation black, square leading	-	I	I	I	I	215	319	Add £ 83
Imitation black, diamond leading	-	J	J	J	j	215	319	Add £ 83

Please state window code on order

GRP Premier panel door - single door options:

Factory pre-framed single door	add £ 90
Diecast metal handles with matching base plates: brass effect, chrome effect and white	add £ 32
Door without inside flow-coat	deduct £ 100
Poly-wrapping	add £ 14
Additional Lock Kit, C-type/ R-type (will be fitted onto door if ordered at the same time)	add £ 42
Retractable plus gear available on 1931, 1981 and 2136 mm high doors up to 2284 mm wide	add £ 27

Single door

Internal Timber frame opening
Width x Height
(mm x mm)

	STAMFORD		ARDEN		ASHURST ¹		KENMORE		HAZELBURY ²		PENSURST ³		HARTFIELD ⁴		LINGFIELD		DERWENT		SWINTON	
	C	R	C	R	C	R	C	R	C	R	C	R	C	R	C	R	C	R	C	R
Up to 2133 x 1931-1980	-	-	-	-	-	-	-	-	-	-	1514	1553	-	-	-	-	-	-	-	-
Up to 2133 x 1981-2136	-	-	-	-	1397	1436	-	-	-	-	1514	1553	-	-	-	-	-	-	-	-
Up to 2133 x 2137-2286	-	-	-	-	1603	1642	-	-	-	-	-	1751	-	-	-	-	-	-	-	-
2134-2439 x 1931-1980	-	-	-	-	-	-	-	-	1738	1777	1738	1777	-	-	-	-	-	-	-	-
2134-2439 x 1981-2136	1661	1700	1598	1637	1598	1637	1616	1655	1738	1777	1738	1777	1738	1777	1738	1777	1847	1886	1738	1777
2134-2439 x 2137-2286	-	-	-	-	-	1897	-	-	-	-	-	2016	-	-	-	2016	-	-	-	-
2440-2590 x 1931-1980	-	-	-	-	-	-	-	-	-	-	-	-	-	-	-	-	-	-	-	-
2440-2590 x 1981-2136	-	1922*	-	1826	-	1826*	-	1864	-	-	-	-	-	-	-	1987	-	-	-	-
2440-2590 x 2137-2286	-	-	-	-	-	2091*	-	-	-	-	-	-	-	-	-	2215	-	-	-	-
2591-2744 x 1931-1980	-	-	-	-	-	-	-	-	-	-	-	-	-	-	-	-	-	-	-	-
2591-2744 x 1981-2136	-	1880*	-	1826*	-	1826*	-	1864*	-	-	-	-	-	-	-	1987	-	-	-	-
2591-2744 x 2137-2286	-	-	-	-	-	2091*	-	-	-	-	-	-	-	-	-	2215	-	-	-	-
2745-2896 x 1931-1980	-	-	-	-	-	-	-	-	-	-	-	-	-	-	-	-	-	-	-	-
2745-2896 x 1981-2136	-	2111*	-	1982*	-	1982*	-	2039*	-	-	-	-	-	-	-	-	-	-	-	-
2745-2896 x 2137-2286	-	-	-	-	-	2267*	-	-	-	-	-	-	-	-	-	-	-	-	-	-
2897-3049 x 1931-1980	-	-	-	-	-	-	-	-	-	-	-	2163	-	-	-	-	-	-	-	-
2897-3049 x 1981-2136	-	2111*	-	1982*	-	1982*	-	2039*	-	-	-	2163	-	-	-	2163	-	-	-	-
2897-3049 x 2137-2286	-	-	-	-	-	1982*	-	-	-	-	-	2416	-	-	-	2416	-	-	-	-

C = Canopy gear, R = Retractable gear

¹ Ashurst width available from 2016 mm.

² Hazelbury height available from 1960 mm.

³ Penshurst width available from 2083 mm.

⁴ Hartfield doors not available in matt white colour option.

Chassis colour - White (RAL 9016) for Gloss White Doors, Black (RAL 9005) for Ebony coloured doors and Brown (RAL 8028) for all other timber effect GRP doors.

For window options please see grid on page 10.

* Doors only available with electric operation (Handle and Locking not available).

GRP Premier panel door - single door options:

Factory pre-framed purpose-made doors

(available as framed canopy in all applicable sizes and as framed retractable only in standard heights)

add £ 90

Diecast metal handles with matching base plates: brass effect, chrome effect and white

add £ 32

Door without inside flow-coat

deduct £ 100

Poly-wrapping

add £ 14

Additional Lock Kit, C-type/ R-type (will be fitted onto door if ordered at the same time)

add £ 42

Retractable plus gear available on 1931, 1981 and 2136 mm high doors up to 2284 mm wide

add £ 27

Double door

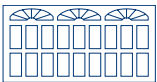
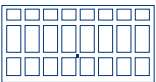
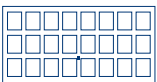
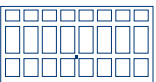
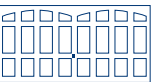
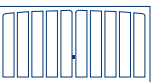
Size Code	Internal Timber frame opening Width x Height (mm x mm)						
		STAMFORD	ARDEN	ASHURST	KENMORE	HAZELBURY	PENSHURST
		R	R	R	R	R	R
1166	3354 x 1981	-	1927	-	2002	-	2110
1170	3354 x 2136	-	1927	-	2002	-	2110
1266	3659 x 1981	-	2085*	-	2177*	-	2287
1270	3659 x 2136	-	2085*	-	2177*	-	2287
1366	3964 x 1981	-	2240*	2240	2352*	-	2461
1370	3964 x 2136	-	2240*	-	2352*	-	2461
1466	4269 x 1981	2648*	2397	2397	2532	2776	2637
1470	4269 x 2136	2648*	2397	2397	2532	2776	2637

Double door

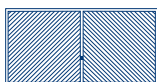
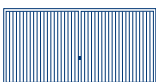
Size Code	Internal Timber frame opening Width x Height (mm x mm)		
		HARTFIELD ¹	SWINTON
		R	R
1166	3354 x 1981	-	-
1170	3354 x 2136	-	-
1266	3659 x 1981	-	-
1270	3659 x 2136	-	-
1366	3964 x 1981	-	-
1370	3964 x 2136	-	-
1466	4269 x 1981	-	2648
1470	4269 x 2136	2637	2648









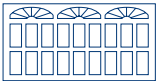
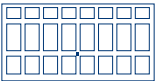
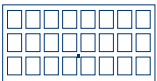
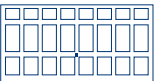
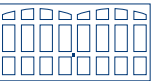

R = Retractable gear

¹ Hartfield doors not available in matt white colour option.

* Doors only available with electric operation (Handle and Locking not available).

GRP Window options

(for standard and purpose-made double doors)

							Additional Cost (Width mm)	
		STAMFORD	ARDEN	ASHURST	KENMORE	HAZELBURY	3354 - 3963	3964 - 4269
	Semi-translucent, no leading	A	A	A	A	A	213	241
	Semi-translucent, diamond leading	-	B	B	B	B	347	418
	Semi-translucent, square leading	-	C	C	C	C	347	418
	Smoked, no leading	D	D	-	D	D	213	241
	Smoked, diamond leading	-	E	-	E	E	347	418
	Smoked, square leading	-	F	-	F	F	347	418
	Imitation black, sunrise	G	-	-	-	-	62	83
	Imitation black, no leading	-	H	H	H	H	213	241
	Imitation black, square leading	-	I	I	I	I	347	418
	Imitation black, diamond leading	-	J	J	J	J	347	418

Please state window code on order

GRP Premier panel door - double door options:

Factory produced steel frame kit for double doors	add £ 145
Diecast metal handles with matching base plates: brass effect, chrome effect and white	add £ 32
Door without inside flow-coat	deduct £ 100
Poly-wrapping	add £ 28

Double door

Internal Timber
frame opening
Width x Height
(mm x mm)

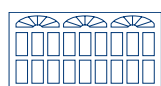

STAMFORD

R

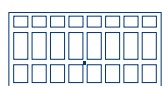

ARDEN

R

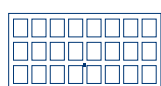

ASHURST

R

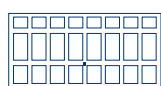

KENMORE

R

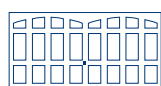

HAZELBURY

R



PENSHURST

R

3050 – 3355 x 1981-2136	-	2058	-	2142	-	2254
3050 – 3355 x 2137-2286	-	-	-	-	-	2592
3356 – 3660 x 1981-2136	-	2213*	-	2316*	-	2427
3356 – 3660 x 2137-2286	-	-	-	-	-	2789
3661 – 3965 x 1981-2136	-	2367*	-	2490*	-	2254
3661 – 3965 x 2137-2286	-	-	-	-	-	2992
3966 – 4117 x 1981-2136	2786*	2522*	2522	2657*	-	2767
3966 – 4117 x 2137-2286	-	-	2902	-	-	3426
4118 – 4269 x 1981-2136	2786*	2522	2522	2657	2812	2767
4118 – 4269 x 2137-2286	-	-	2902	-	-	3183

R = Retractable gear

Doors with windows may have cross bracing and or locking rods behind the windows depending upon the size and gear type.

Factory framed double purpose-made doors are only available in standard sized heights (1981 mm and 2136 mm) but in any width in accordance with the above table.

Chassis colour - White (RAL 9016) for Gloss White Doors, Black (RAL 9005) for Ebony coloured doors and Brown (RAL 8028) for all other timber effect GRP doors.

Certain panel configurations may only be available without handle or locking, therefore only suitable for electric operation (consult Garador sales office for exact details).

For window options please see grid on page 12.

* Doors only available with electric operation (Handle and Locking not available).

GRP Premier panel door - double door options:

Factory produced steel frame kit for double doors (available for 1981 mm and 2136 mm heights only)	add £ 145
Diecast metal handles with matching base plates: brass effect, chrome effect and white	add £ 32
Door without inside flow-coat	deduct £ 100
Poly-wrapping	add £ 28

Single door

Size Code	Internal Timber frame opening Width x Height (mm x mm)	KINGSBURY		CHEVRON CEDAR		VERTICAL CEDAR		BARRINGTON		SANDHURST ¹		CAVENDISH	
		C	R	C	R	C	R	C	R	C	R	C	R
7066	2134 x 1981	1344	1383	1344	1383	1027	1066	1389	1428	1344	1383	861	900
7070	2134 x 2136	1440	1479	1440	1479	1093	1132	1488	1527	1440	1479	921	960
7566	2259 x 1981	1523	1562	1523	1562	1093	1132	1488	1527	1523	1562	983	1022
7570	2259 x 2136	1483	1522	1483	1522	1158	1197	1529	1568	1483	1522	1049	1088
7666	2284 x 1981	1458	1497	1458	1497	1104	1143	1503	1542	1458	1497	948	987
7670	2284 x 2136	1498	1537	1498	1537	1170	1209	1544	1583	1498	1537	1019	1058
8066	2439 x 1981	1585	1624	1585	1624	1188	1227	1630	1669	1585	1624	1087	1126
8070	2439 x 2136	1624	1663	1624	1663	1251	1290	1670	1709	1624	1663	1151	1190
9066	2744 x 1981	-	-	-	-	-	1389	-	-	-	-	-	-
9070	2744 x 2136	-	-	-	-	-	1457	-	-	-	-	-	-
1066	3049 x 1981	-	-	-	-	-	1543	-	-	-	-	-	-
1070	3049 x 2136	-	-	-	-	-	1612	-	-	-	-	-	-

C = Canopy gear, R = Retractable gear

Single door

Size Code	Internal Timber frame opening Width x Height (mm x mm)	WOLSEY		SHAFTESBURY		SEYMOUR		TUDOR		BOSWORTH	
		C	R	C	R	C	R	C	R	C	R
7066	2134 x 1981	1095	1134	1035	1074	1035	1074	1035	1074	1203	1242
7070	2134 x 2136	1135	1174	1075	1114	1075	1114	1075	1114	1239	1278
7566	2259 x 1981	1252	1291	1188	1227	1188	1227	1188	1227	1254	1293
7570	2259 x 2136	1276	1315	1214	1253	1214	1253	1214	1253	1274	1313
7666	2284 x 1981	1265	1304	1200	1239	1200	1239	1200	1239	1239	1278
7670	2284 x 2136	1291	1330	1225	1264	1225	1264	1225	1264	1274	1313
8066	2439 x 1981	-	-	-	-	-	-	-	-	1296	1335
8070	2439 x 2136	-	-	-	-	-	-	-	-	1333	1372
9066	2744 x 1981	-	-	-	-	-	-	-	-	-	1477
9070	2744 x 2136	-	-	-	-	-	-	-	-	-	1580
1066	3049 x 1981	-	-	-	-	-	-	-	-	-	1671
1070	3049 x 2136	-	-	-	-	-	-	-	-	-	1671

C = Canopy gear, R = Retractable gear

¹ Sandhurst doors may have cross bracing and or locking rods behind the windows depending upon the size and gear type.

Sandhurst window options



Prices stated per door	PLAIN	GEORGIAN	DIAGONAL
	no on-cost	£ 84	£ 84

Windows are manufactured from 4 mm safety glass. Please state on order if clear or stippled panes required.

Timber panel door - single door options:

Factory pre-framed single door	add £ 90
Diecast metal handles with matching base plates: brass effect, chrome effect and white	add £ 32
Poly-wrapping	add £ 14
Bottom weatherseal, 2405 mm length (suitable for gaps up to 15 mm between the door and the floor level)	add £ 25
Bottom weatherseal, 3000 mm length (suitable for gaps up to 15 mm between the door and the floor level)	add £ 29
Additional Lock Kit, C-type/ R-type (will be fitted onto door if ordered at the same time)	add £ 42
Retractable plus gear available on 1931, 1981 and 2136 mm high doors up to 2284 mm wide	add £ 27

Single door

Internal Timber frame opening Width x Height (mm x mm)			 VERTICAL CEDAR		 BOSWORTH	
			C	R	C	R
1930-1984	x	1931-1981	1172	1211	-	-
1930-1984	x	1982-2136	1215	1254	-	-
1930-1984	x	2137-2286	-	1306	-	-
1930-1984	x	2287-2439	-	1345	-	-
1985-2134	x	1931-1981	1190	1229	-	-
1985-2134	x	1982-2136	1215	1254	1252	1291
1985-2134	x	2137-2286	-	1345	-	1345
1985-2134	x	2287-2439	-	1402	-	1402
2135-2284	x	1931-1981	1252	1291	-	-
2135-2284	x	1982-2136	1288	1327	1288	1327
2135-2284	x	2137-2286	-	1402	-	1402
2135-2284	x	2287-2439	-	1490	-	1490
2285-2499	x	1931-1981	1288	1327	-	-
2285-2499	x	1982-2136	1471	1510	1350	1389
2285-2499	x	2137-2286	-	1490	-	1490
2285-2499	x	2287-2439	-	1597	-	1597
2500-2590	x	1931-1981	-	1402	-	-
2500-2590	x	1982-2136	-	1490	-	1490
2500-2590	x	2137-2286	-	1597	-	1597
2500-2590	x	2287-2439	-	1692	-	1692
2591-2744	x	1931-1981	-	1490	-	-
2591-2744	x	1982-2136	-	1597	-	1597
2591-2744	x	2137-2286	-	1692	-	1692
2591-2744	x	2287-2439	-	1806	-	1806
2745-3049	x	1931-1981	-	1597	-	-
2745-3049	x	1982-2136	-	1692	-	1692

C = Canopy gear, R = Retractable gear

Factory pre-framed retractable purpose-made doors are only available in standard heights (1931 mm, 1981mm, 2136 mm, and 2286 mm) but in any width in accordance with the above table.

Certain panel configurations may only be available without handle or locking, therefore only suitable for electric operation. (consult Garador sales office for exact details).

Timber panel door - single door options:



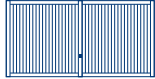
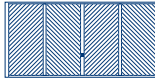
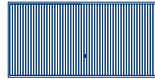
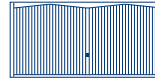
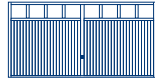
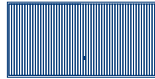

Factory pre-framed purpose-made doors	
(available as framed canopy in all applicable sizes and as framed retractable only in standard heights)	add £ 90
Diecast metal handles with matching base plates: brass effect, chrome effect and white	add £ 32
Poly-wrapping	add £ 14
Bottom weatherseal, 2405 mm length (suitable for gaps up to 15 mm between the door and the floor level)	add £ 25
Bottom weatherseal, 3000 mm length (suitable for gaps up to 15 mm between the door and the floor level)	add £ 29
Additional Lock Kit, C-type/ R-type (will be fitted onto door if ordered at the same time)	add £ 42
Retractable plus gear available on 1931, 1981 and 2136 mm high doors up to 2284 mm wide	add £ 27

Double door

Size Code	Internal Timber frame opening Width x Height (mm x mm)						
		KINGSBURY	CHEVRON CEDAR	VERTICAL CEDAR	BARRINGTON	SANDHURST ¹	CAVENDISH
		R	R	R	R	R	R
1466	4269 x 1981	3260	3260	2546	3349	3260	2251
1470	4269 x 2136	3260	3260	2546	3349	3260	2251

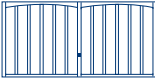
R = Retractable gear

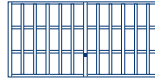

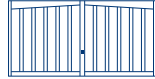
Double door

Size Code	Internal Timber frame opening Width x Height (mm x mm)					
		SHAFTESBURY	SEYMOUR	WOLSEY	TUDOR	BOSWORTH
		R	R	R	R	R
1466	4269 x 1981	2480	2480	2662	2480	2606
1470	4269 x 2136	2480	2480	2662	2480	2606

R = Retractable gear

¹ Sandhurst doors may have cross bracing and or locking rods behind the windows depending upon the size and gear type.

Sandhurst window options

Prices stated per door			
	PLAIN	GEORGIAN	DIAGONAL
	no on-cost	£ 120	£ 120



Windows are manufactured from 4 mm safety glass. Please state on order if clear or stippled panes required.

Timber panel door - double door options:

Factory produced steel frame kit for double doors	add £ 145
Diecast metal handles with matching base plates: brass effect, chrome effect and white	add £ 32
Bottom weatherseal, 2405 mm length (suitable for gaps up to 15 mm between the door and the floor level)	add £ 25
Bottom weatherseal, 3000 mm length (suitable for gaps up to 15 mm between the door and the floor level)	add £ 29
Poly-wrapping	add £ 28

Double door

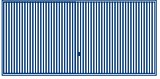
Internal Timber
frame opening
Width x Height
(mm x mm)

			
		VERTICAL CEDAR	BOSWORTH
		R	R
2745-3049	x 2137-2286	2226	2226
2745-3049	x 2287-2439	-	-
3050-3354	x 1931-1981	2135	-
3050-3354	x 1982-2136	2226	2226
3050-3354	x 2137-2286	2325	2325
3050-3354	x 2287-2439	-	-
3355-3659	x 1931-1981	2226	-
3355-3659	x 1982-2136	2325	2325
3355-3659	x 2137-2286	2490	2490
3355-3659	x 2287-2439	-	-
3660-3967	x 1931-1981	2325	-
3660-3967	x 1982-2136	2490	2490
3660-3967	x 2137-2286	2637	2637
3660-3967	x 2287-2439	-	-
3968-4269	x 1931-1981	2637	-
3968-4269	x 1982-2136	2673	2673
3968-4269	x 2137-2286	-	-
3968-4269	x 2287-2439	-	-
4270-5000	x 1931-1981	2949	-
4270-5000	x 1982-2136	3003	-

R = Retractable gear

Certain panel configurations may only be available without handle or locking, therefore only suitable for electric operation (consult Garador sales office for exact details).

Timber panel door - double door options:

Factory produced steel frame kit for double doors (available for 1981 mm and 2136 mm heights only)	add £ 145
Diecast metal handles with matching base plates: brass effect, chrome effect and white	add £ 32
Bottom weatherseal, 2405 mm length (suitable for gaps up to 15 mm between the door and the floor level)	add £ 25
Bottom weatherseal, 3000 mm length (suitable for gaps up to 15 mm between the door and the floor level)	add £ 29
Poly-wrapping	add £ 28

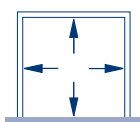

Internal frame size
On-site timber frame

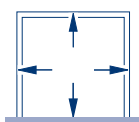

Pre-framed canopy door
overall frame sizes shown *

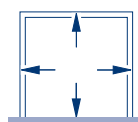

Pre-framed retractable door
overall frame sizes shown *

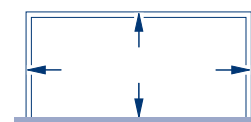

Pre-framed double door
overall frame sizes shown *

Size Code	Width x Height (mm x mm)	Width x Height (mm x mm)	Width x Height (mm x mm)	Width x Height (mm x mm)
6660	1984 x 1830	2094 x 1888	-	-
6664	1984 x 1931	2094 x 1989	2124 x 1989	-
6666	1984 x 1981	2094 x 2039	2124 x 2039	-
6670	1984 x 2136	2094 x 2194	2124 x 2194	-
61064	2084 x 1931	2194 x 1989	2224 x 1989	-
61066	2084 x 1981	2194 x 2039	2224 x 2039	-
61070	2084 x 2136	2194 x 2194	2224 x 2194	-
7060	2134 x 1830	2244 x 1888	-	-
7063	2134 x 1905	2244 x 1963	-	-
7064	2134 x 1931	2244 x 1989	2274 x 1989	-
7066	2134 x 1981	2244 x 2039	2274 x 2039	-
7070	2134 x 2136	2244 x 2194	2274 x 2194	-
7076	2134 x 2286	-	2274 x 2344	-
7164	2170 x 1931	2280 x 1989	2310 x 1989	-
7166	2170 x 1981	2280 x 2039	2310 x 2039	-
7170	2170 x 2136	2280 x 2194	2310 x 2194	-
7176	2170 x 2286	-	2310 x 2344	-
7364	2224 x 1931	2334 x 1989	2364 x 1989	-
7366	2224 x 1981	2334 x 2039	2364 x 2039	-
7370	2224 x 2136	2334 x 2194	2364 x 2194	-
7564	2259 x 1931	2369 x 1989	2399 x 1989	-
7566	2259 x 1981	2369 x 2039	2399 x 2039	-
7570	2259 x 2136	2369 x 2194	2399 x 2194	-
7576	2259 x 2286	-	2399 x 2344	-
7664	2286 x 1931	2394 x 1989	2424 x 1989	-
7666	2286 x 1981	2394 x 2039	2424 x 2039	-
7670	2286 x 2136	2394 x 2194	2424 x 2194	-
7676	2286 x 2286	-	2424 x 2344	-
8064	2439 x 1931	2549 x 1989	2579 x 1989	-
8066	2439 x 1981	2549 x 2039	2579 x 2039	-
8070	2439 x 2136	2549 x 2194	2579 x 2194	-
8076	2439 x 2286	-	2579 x 2344	-
8666	2590 x 1981	-	2730 x 2039	-
8670	2590 x 2136	-	2730 x 2194	-
8676	2590 x 2286	-	2730 x 2344	-
9066	2744 x 1981	-	2884 x 2039	-
9070	2744 x 2136	-	2884 x 2194	-
9076	2744 x 2286	-	2884 x 2344	-
1066	3049 x 1981	-	3189 x 2039	-
1070	3049 x 2136	-	3189 x 2194	-
1076	3049 x 2286	-	-	3189 x 2344
1166	3354 x 1981	-	-	3494 x 2039
1170	3354 x 2136	-	-	3494 x 2194
1176	3354 x 2286	-	-	3494 x 2344
1266	3659 x 1981	-	-	3799 x 2039
1270	3659 x 2136	-	-	3799 x 2194
1276	3659 x 2286	-	-	3799 x 2344
1366	3964 x 1981	-	-	4104 x 2039
1370	3964 x 2136	-	-	4104 x 2194
1376	3964 x 2286	-	-	4104 x 2344
1466	4269 x 1981	-	-	4409 x 2039
1470	4269 x 2136	-	-	4409 x 2194
1566	4574 x 1981	-	-	4714 x 2039
1570	4574 x 2136	-	-	4714 x 2194
1666	4879 x 1981	-	-	5019 x 2039
1670	4879 x 2136	-	-	5019 x 2194

* No fitting clearance allowed

Canopy Gear Specifications

The canopy gear allows the door to travel in vertical tracks and is counterbalanced by an overhead torsion spring. The nominal drive through is 40 mm less than the opening width and 130 mm less than the opening height.

In the open position, the door projects approximately one third of the door height, forming a canopy.

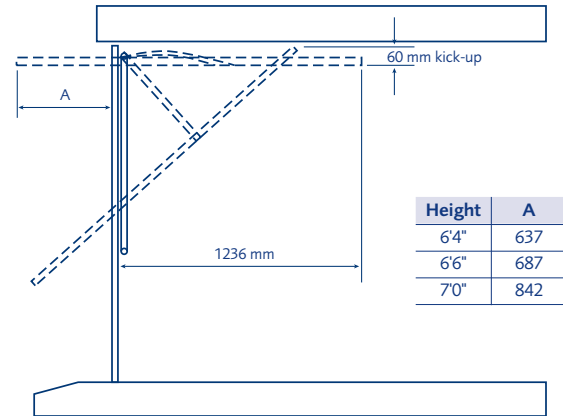

Canopy garage door with on-site timber frame

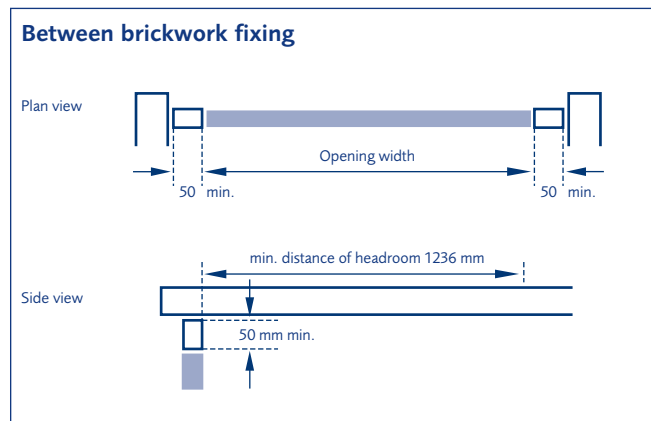
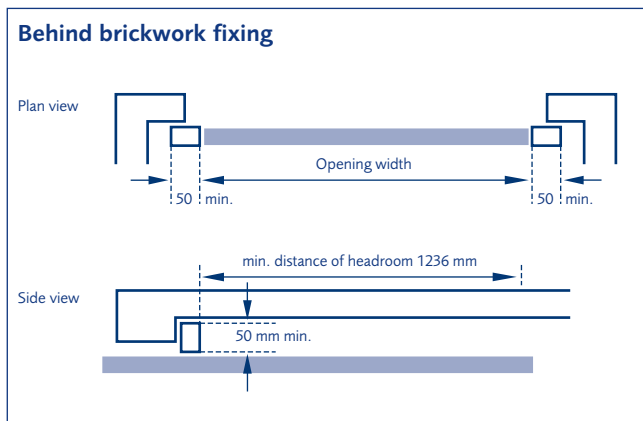

Canopy garage door factory pre-framed

The garage door is supplied factory fitted to a steel box section frame and is secured to the brickwork by using just 7 fixings.

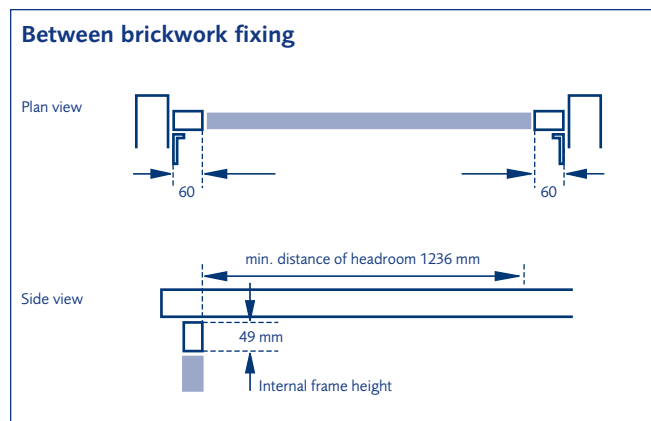
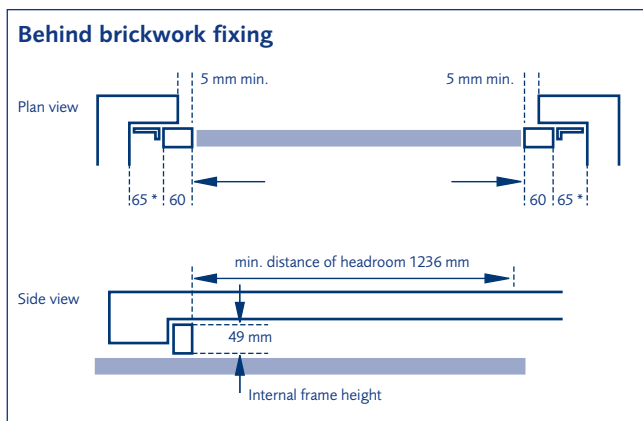

* required for brackets

Single & Double Retractable Gear Specifications

The retractable gear allows the door to be retracted inside the garage when open by means of horizontal overhead tracks supported by wall or ceiling mounted suspension brackets. This gear is available as an option for single doors and comes as standard with double garage doors.

The nominal drive through clearance is 105 mm less than the opening width and 110 mm less than the opening height for single doors and 140 mm less than the opening height for double doors.

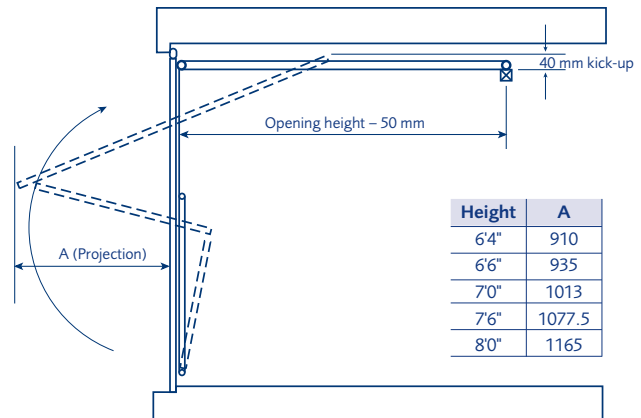

Retractable garage door with on-site timber frame

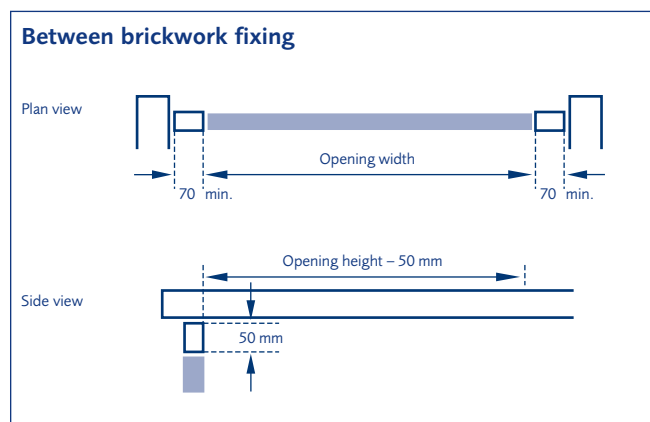
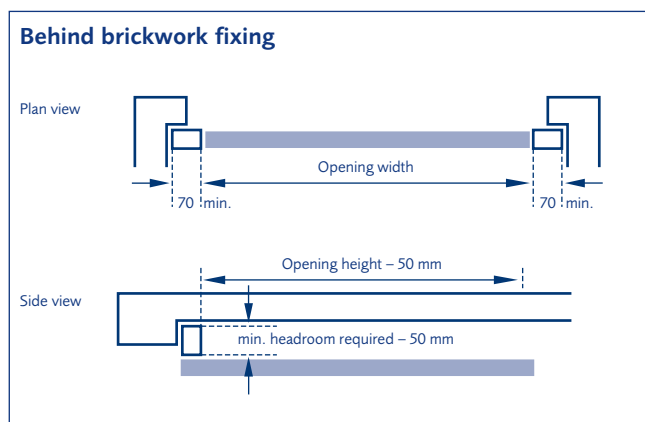

Retractable garage door factory pre-framed

The garage door is supplied factory fitted to a steel box section frame and is secured to the brickwork by using just 7 fixings.

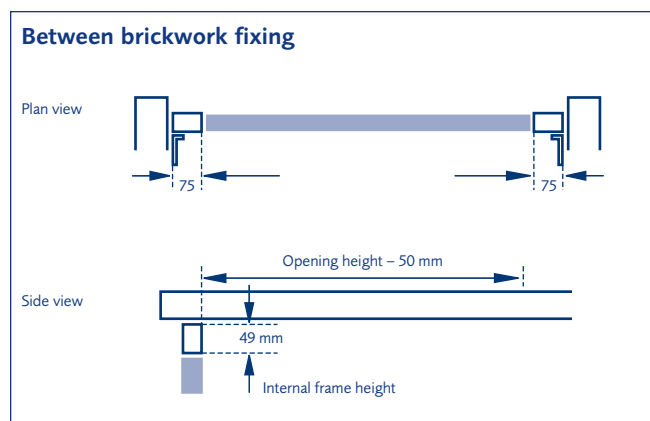
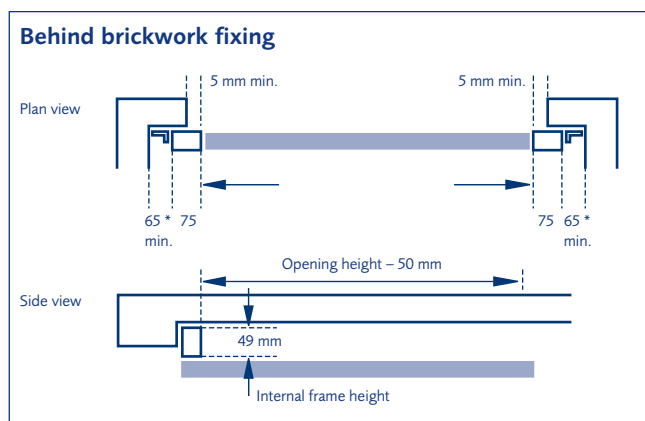

* required for brackets

Retractable Plus Gear

For any door up to a width of 2284 mm in any of the three standard heights Retractable Plus Gear is available. This gear type creates clear drive through width at the crucial wing mirror height.

Door height	Clear height below lifting arms
7'0"	1260
6'6"	1105
6'4"	1055

Side-hinged Door Specifications

Door leaves supplied factory pre-framed ready for site installation. Fixed leaf (RH side when viewed from inside) fitted with tower bolts at top and bottom of inner leading edge. The floor will need to be finished and level for the bottom tower bolts to engage.

The nominal drive through clearance is 124 mm less than the opening width and 12 mm less than the opening height.

Side-hinged door factory pre-framed

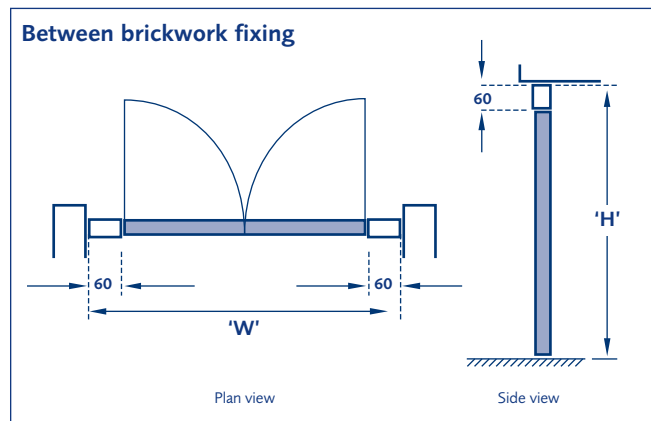
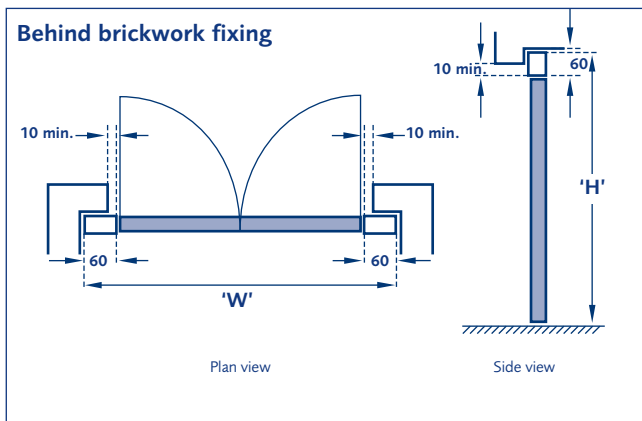

General Information for Sectional Doors

SECTIONAL

Door sections:	Made of galvanized steel. Available as Classic (single-skin), Standard (semi-insulated) and Premium (fully insulated) versions. Standard and Premium doors are PU-foam insulated (100% CFC-free). Bottom door section comes with floor seal.															
Surface:	Outside: woodgrain-embossed steel with powder-coat or foil-coated for timber-effect. Inside: pebble texture.															
Spring arrangement:	All doors up to 3049 mm wide come with tension springs as standard and torsion springs are available at extra cost. All doors over 3050 mm wide come with torsion springs as standard. Low headroom application available at extra cost for all sizes over 3050 mm.															
Side Frames & Fascia:	Sectional doors are designed to be fitted behind the reveals and side frames are supplied white in colour. A single skin fascia is supplied with all doors which is finished in the same colour as the door sections.															
Stock availability:	Standard items are generally ex-stock in White (RAL 9016) and Brown (RAL 8028), other colour options on a 4 to 6 week lead-time.															
Colours:	Steel woodgrain-embossed doors with powder-coat can be ordered in almost any colour from the RAL colour chart.															
Standard colours are:	<table><tr><td>- Light Ivory RAL 1015</td><td>- Moss Green RAL 6005</td><td>- Window Grey RAL 7040</td></tr><tr><td>- Ruby Red RAL 3003</td><td>- Fir Tree Green RAL 6009</td><td>- Ochre Brown RAL 8001</td></tr><tr><td>- Sapphire Blue RAL 5003</td><td>- Anthracite Grey RAL 7016</td><td>- Clay Brown RAL 8003</td></tr><tr><td>- Steel Blue RAL 5011</td><td>- Stone Grey RAL 7030</td><td>- Terra Brown RAL 8028</td></tr><tr><td>- Pigeon Blue RAL 5014</td><td>- Light Grey RAL 7035</td><td>- White Aluminium RAL 9006</td></tr></table>	- Light Ivory RAL 1015	- Moss Green RAL 6005	- Window Grey RAL 7040	- Ruby Red RAL 3003	- Fir Tree Green RAL 6009	- Ochre Brown RAL 8001	- Sapphire Blue RAL 5003	- Anthracite Grey RAL 7016	- Clay Brown RAL 8003	- Steel Blue RAL 5011	- Stone Grey RAL 7030	- Terra Brown RAL 8028	- Pigeon Blue RAL 5014	- Light Grey RAL 7035	- White Aluminium RAL 9006
- Light Ivory RAL 1015	- Moss Green RAL 6005	- Window Grey RAL 7040														
- Ruby Red RAL 3003	- Fir Tree Green RAL 6009	- Ochre Brown RAL 8001														
- Sapphire Blue RAL 5003	- Anthracite Grey RAL 7016	- Clay Brown RAL 8003														
- Steel Blue RAL 5011	- Stone Grey RAL 7030	- Terra Brown RAL 8028														
- Pigeon Blue RAL 5014	- Light Grey RAL 7035	- White Aluminium RAL 9006														
Handle:	Foil-coated doors available in different timber-effects. All doors light grey on the inside. Sectional doors are supplied ex works for automatic operation, i. e. without handle hole and lock. Factory-fitted handle and lock are available with a 2 week increase in lead-time. For electrical operation of a garage with no other personal access, an emergency release kit must be fitted.															
Packaging:	Sectional doors are provided in a palletted format shrink wrapped for easy handling.															
Warranty:	For details see page 34.															

GEAR

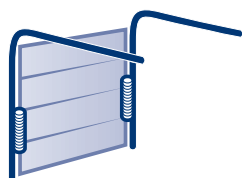

Tension spring

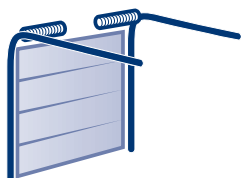

Torsion spring

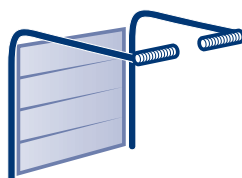





Low headroom torsion spring fitting

OPERATORS

GaraMatic operators are an ideal match for all current Garador up & over and sectional doors. As a tried and tested unit hardware on both the door and the operator are perfectly matched and prepared for easy installation.



Woodgrain Georgian designs

Size Code	Brickwork opening Width x Height (mm x mm)	Georgian small			Georgian medium			Surcharge for Standard Colours	Surcharge for Non-Std. Colours
				No. of pressings/ windows per section			No. of pressings/ windows per section		
		STANDARD	CLASSIC		PREMIUM	CLASSIC			
61062	2080 x 1875	868	659	4	1044	659	2	86	168
61066	2080 x 2000	868	-	4	1044	-	2	92	180
610610	2080 x 2080	868	-	4	1044	-	2	92	180
61070	2080 x 2125	868	659	4	1044	659	2	95	186
7066	2134 x 2000	868	662	4	1044	662	2	94	184
7070	2134 x 2125	868	662	4	1044	662	2	100	195
7666	2286 x 2000	1011	705	4	1121	705	3	101	197
7670	2286 x 2125	1011	705	4	1121	705	3	107	209
7674	2286 x 2250	1027	735	4	1208	735	3	113	221
7679	2286 x 2375	1028	851	4	1233	851	3	119	233
7682	2286 x 2500	1028	851	4	1279	851	3	126	246
8066	2438 x 2000	1011	739	4	1151	739	3	107	209
8070	2438 x 2125	1011	739	4	1151	739	3	114	223
8074	2438 x 2250	1074	763	4	1286	763	3	134	262
8079	2438 x 2375	1070	887	4	1307	887	3	114	223
8082	2438 x 2500	1070	887	4	1331	887	3	121	237
8666	2591 x 2000	1074	769	5	1220	769	3	121	237
8670	2591 x 2125	1074	769	5	1220	769	3	127	248
9066	2743 x 2000	1113	868	5	1277	868	3	121	237
9070	2743 x 2125	1113	868	5	1277	868	3	128	250
9666	2895 x 2000	1155	877	5	1439	877	3	127	248
9670	2895 x 2125	1155	877	5	1439	877	3	135	264
1066	3048 x 2000	1439	947	5	1626	947	4	134	262
1070	3048 x 2125	1439	947	5	1626	947	4	142	278
1166	3353 x 2000	1538	-	5	1738	1274	4	148	289
1170	3353 x 2125	1538	-	5	1738	1274	4	157	307
1266	3657 x 2000	1588	-	6	1780	1436	4	161	315
1270	3657 x 2125	1588	-	6	1780	1436	4	171	334
1366	3962 x 2000	1639	-	6	1780	1469	5	174	340
1370	3962 x 2125	1639	-	6	1780	1469	5	185	362
1466	4267 x 2000	1431	-	7	1622	1583	5	188	367
1470	4267 x 2125	1431	-	7	1622	1583	5	199	389
14666	4420 x 2000	1670	-	7	1770	1626	5	194	379
14670	4420 x 2125	1670	-	7	1770	1626	5	207	405
1566	4572 x 2000	1697	-	7	1790	1638	6	201	393
1570	4572 x 2125	1697	-	7	1790	1638	6	214	418
15666	4725 x 2000	1720	-	7	1893	1691	6	208	407
15670	4725 x 2125	1720	-	7	1893	1691	6	221	432
1666	4877 x 2000	1749	-	8	1858	1698	6	215	420
1670	4877 x 2125	1749	-	8	1858	1698	6	228	446





As standard with tension spring fitting, torsion spring fitting available for Premium doors at £ 46 surcharge.

As standard with torsion spring fitting.

Purpose-made sizes available upon request. Non standard colours also available upon request.







Window options

Prices stated per window

					WINDOW FRAMES IN STANDARD COLOUR TO MATCH DOOR - ADDITIONAL:
	GEORGIAN STANDARD	GEORGIAN CROSS	GEORGIAN DIAMOND	GEORGIAN SUNRISE	
Premium doors	80	93	93	93	21
Standard doors	77	85	85	85	21
Classic doors	68	77	77	77	21

Please state on order if clear or crystal panes.

Woodgrain Linear designs

Size Code	Brickwork opening Width x Height (mm x mm)	 Linear small			 Linear medium			No. of windows per section	Surcharge for Standard Colours	Surcharge for Non-Std. Colours
				No. of windows per section						
		PREMIUM	CLASSIC		PREMIUM	STANDARD	CLASSIC			
61062	2080 x 1875	907	576	2	907	721	576	2	86	168
61066	2080 x 2000	907	-	2	907	721	-	2	92	180
610610	2080 x 2080	907	576	2	907	721	576	2	95	186
7066	2134 x 2000	907	590	2	907	721	590	2	94	184
7070	2134 x 2125	907	590	2	907	721	590	2	100	195
7666	2286 x 2000	909	634	2	909	739	634	2	101	197
7670	2286 x 2125	909	634	2	909	739	634	2	107	209
7674	2286 x 2250	945	718	2	945	861	718	2	113	221
7679	2286 x 2375	987	718	2	987	861	718	2	119	233
7682	2286 x 2500	1028	718	2	1028	861	718	2	126	246
8066	2438 x 2000	966	662	2	966	768	662	2	107	209
8070	2438 x 2125	966	662	2	966	768	662	2	114	223
8074	2438 x 2250	990	699	2	990	903	699	2	134	262
8079	2438 x 2375	1036	747	2	1036	903	747	2	114	223
8082	2438 x 2500	1082	747	2	1082	903	747	2	121	237
8666	2591 x 2000	968	684	3	968	780	684	3	121	237
8670	2591 x 2125	968	684	3	968	780	684	3	127	248
9066	2743 x 2000	1057	740	3	1057	831	740	3	121	237
9070	2743 x 2125	1057	740	3	1057	831	740	3	128	250
9666	2895 x 2000	1118	755	3	1118	870	755	3	127	248
9670	2895 x 2125	1118	755	3	1118	870	755	3	135	264
1066	3048 x 2000	1118	798	3	1118	883	798	3	134	262
1070	3048 x 2125	1118	798	3	1118	883	798	3	142	278
1166	3353 x 2000	1337	1053	3	1337	1194	-	3	148	289
1170	3353 x 2125	1337	1053	3	1337	1194	-	3	157	307
1266	3657 x 2000	1513	1167	4	1513	1232	-	4	161	315
1270	3657 x 2125	1513	1167	4	1513	1232	-	4	171	334
1366	3962 x 2000	1556	1191	4	1556	1258	-	4	174	340
1370	3962 x 2125	1556	1191	4	1556	1258	-	4	185	362
1466	4267 x 2000	1361	1304	4	1361	1327	-	4	188	367
1470	4267 x 2125	1361	1304	4	1361	1327	-	4	199	389
14666	4420 x 2000	1484	1335	4	1484	1348	-	4	194	379
14670	4420 x 2125	1484	1335	4	1484	1348	-	4	207	405
1566	4572 x 2000	1597	1340	5	1597	1392	-	5	201	393
1570	4572 x 2125	1597	1340	5	1597	1392	-	5	214	418
15666	4725 x 2000	1625	1380	5	1625	1474	-	5	208	407
15670	4725 x 2125	1625	1380	5	1625	1474	-	5	221	432
1666	4877 x 2000	1653	1437	5	1653	1477	-	5	215	420
1670	4877 x 2125	1653	1437	5	1653	1477	-	5	228	446

As standard with tension spring fitting, torsion spring fitting available for Premium doors at £46 surcharge.

As standard with torsion spring fitting.

Purpose-made sizes available upon request. Non standard colours also available upon request.

Window options

Prices stated per window





LINEAR
STANDARD

Premium doors	93
Standard doors	87
Classic doors	73

Please state on order if clear or crystal panes.

Linear windows are only available in white or black. Please state on order.

Timber-effect - Now available in Golden Oak, Rosewood & Dark Oak

Size Code	Brickwork opening Width x Height (mm x mm)	Georgian small		Linear medium	
		 PREMIUM	No. of pressings/windows per section	 PREMIUM	No. of windows per section
61062	2080 x 1875	1194	4	1057	2
61066	2080 x 2000	1194	4	1057	2
61070	2080 x 2125	1194	4	1057	2
7066	2134 x 2000	1175	4	1057	2
7070	2134 x 2125	1175	4	1057	2
7666	2286 x 2000	1353	4	1097	2
7670	2286 x 2125	1353	4	1097	2
7674	2286 x 2250	1391	4	1135	2
7679	2286 x 2375	1431	4	1174	2
7682	2286 x 2500	1471	4	1216	2
8066	2438 x 2000	1371	4	1099	2
8070	2438 x 2125	1371	4	1099	2
8074	2438 x 2250	1409	4	1137	3
8079	2438 x 2375	1450	4	1178	3
8082	2438 x 2500	1490	4	1218	3
8666	2591 x 2000	1450	5	1101	3
8670	2591 x 2125	1449	5	1101	3
9066	2743 x 2000	1497	5	1231	3
9070	2743 x 2125	1497	5	1231	3
9666	2895 x 2000	1618	5	1294	3
9670	2895 x 2125	1618	5	1294	3
1066	3048 x 2000	1618	5	1294	3
1070	3048 x 2125	1618	5	1294	3
1166	3353 x 2000	1932	5	1533	3
1170	3353 x 2125	1932	5	1533	3
1266	3657 x 2000	2170	6	1739	4
1270	3657 x 2125	2170	6	1739	4
1366	3962 x 2000	2265	6	1853	4
1370	3962 x 2125	2265	6	1853	4
1466	4267 x 2000	2015	7	1842	4
1470	4267 x 2125	2015	7	1842	4
14666	4420 x 2000	2356	7	1951	4
14670	4420 x 2125	2356	7	1951	4
1566	4572 x 2000	2451	7	2000	5
1570	4572 x 2125	2451	7	2000	5
15666	4725 x 2000	2451	7	2053	5
15670	4725 x 2125	2451	7	2053	5
1666	4877 x 2000	2451	8	2085	5
1670	4877 x 2125	2451	8	2085	5

As standard with tension spring fitting, torsion spring fitting available for Premium doors at £ 46 surcharge.





As standard with torsion spring fitting.

Purpose-made sizes available on request.

Doors available in Golden Oak, Rosewood and Dark Oak colours (please state with the order).

Window options

Prices stated per window

	 GEORGIAN STANDARD	 GEORGIAN CROSS	 GEORGIAN DIAMOND	 GEORGIAN SUNRISE	 LINEAR STANDARD
Premium doors	99	112	112	112	112

All window frames are painted to match the colour of the door except Linear where only white or black windows are available. Please state with order.

Please state on order if clear or crystal panes.

Sectional Door Options

Sectional door options:

Special anchor set (required if you fix the door between brickwork and fasten the frame on the side) add £ 35
If using special anchor set cover profiles will be required to cover fixing holes.

Please note: frame legs for brown/coloured doors come in white as standard, matching frame cover profiles available.

Frame cover profiles 55 mm or 80 mm wide (must be ordered with the door)

- 55 mm brown or any standard colour	per m of door height	add £ 23
- 80 mm brown or any standard colour	per m of door height	add £ 25
- 55 mm RAL colour to choose	per m of door height	add £ 31
- 80 mm RAL colour to choose	per m of door height	add £ 45
- 55 mm Timber effect	per m of door height	add £ 25
- 80 mm Timber effect	per m of door height	add £ 45

Purpose-made width cut-down service (check for size limitations) add £ 90
(Cut-down service not available on Classic Doors)

Classic black handle set and lock for on-site installation	add £ 24
White finish cast aluminium handle set and lock for on-site installation	add £ 86
Silver finish cast aluminium handle set and lock for on-site installation	add £ 86
Brass effect cast aluminium handle set and lock for on-site installation	add £ 86
Chrome effect stainless steel handle set and lock for on-site installation	add £ 115
Brushed chrome effect stainless steel handle set and lock for on site installation	add £ 115
Factory-fitted handle and lock available with a 2 week increase in lead-time (complete with classic black handle as standard)	add £ 39

Standard headroom torsion spring for sectional door less than 3050 mm wide add £ 45

Low headroom tracks arrangement for torsion spring door over 3050 mm wide add £ 90

Sectional Door Specifications

Sectional doors up to 3050 mm wide and/or 2625 mm high:

These doors come with tension spring fitting. With doors from the Premium range the tension springs can be replaced by torsion springs as an option. Tension springs are suitable for low headroom installations. For a low headroom installation with torsion springs please order low headroom track set separately (changing to a low headroom option is not available as a retrofit).



Sectional garage door with tension spring fitting

Minimum garage dimensions for manually operated doors

Headroom:	100 mm
Sideroom:	90 mm (each side)
Depth into garage:	garage door height + 510 mm
Clear passage height for manually operated doors:	garage door height - 80 mm

Minimum garage dimensions for doors with GaraMatic operator

Headroom:	115 mm
Sideroom:	90 mm (each side)
Depth into garage:	for doors up to 2125 mm high: 3200 mm for doors up to 3000 mm high: 4125 mm
Clear passage height for doors with GaraMatic operator:	garage door height - 30 mm

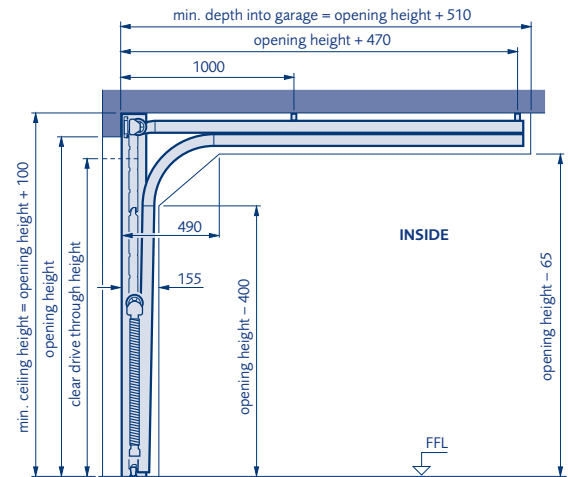

Side view

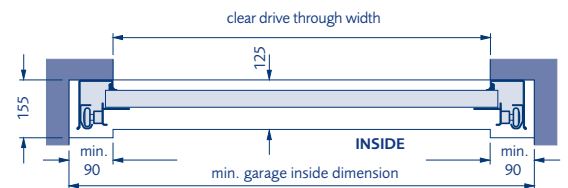

Plan view

Sectional Door Specifications

Sectional doors wider than 3050 mm and/or higher than 2625 mm:

These doors come with torsion springs as standard. For a low headroom installation with torsion springs please order low headroom track pack (changing to a low headroom option is not available as a retrofit).



Sectional garage door with torsion spring fitting

Minimum garage dimensions for manually operated doors

Headroom:	210 mm
Sideroom:	90 mm (each side)
Depth into garage:	garage door height + 510 mm
Clear passage height for manually operated doors:	garage door height - 50 mm.

Minimum garage dimensions for doors with GaraMatic operator

Headroom:	210 mm
Sideroom:	90 mm (each side)
Depth into garage:	for doors up to 2250 mm high: 3200 mm for doors up to 2500 mm high: 3450 mm for doors up to 3000 mm high: 4125 mm

Clear passage height for doors with GaraMatic operator:
full garage door height.

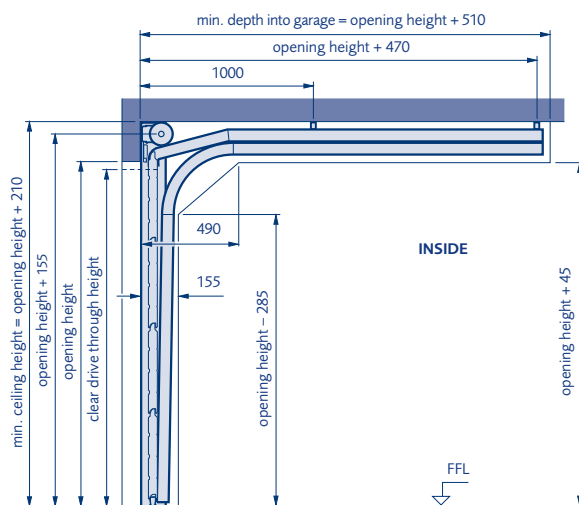

Side view

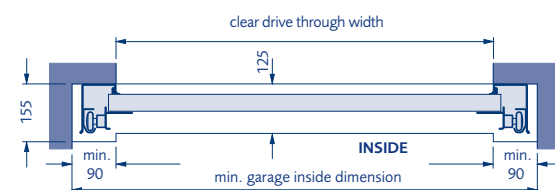

Plan view



Sectional garage door with low headroom torsion spring fitting

Minimum garage dimensions for manually operated doors

Headroom:	100 mm
Sideroom:	90 mm (each side)
Depth into garage:	garage door height + 510 mm
Clear passage height for manually operated doors:	garage door height - 100 mm.

Minimum garage dimensions for doors with GaraMatic operator

Headroom:	115 mm
Sideroom:	90 mm (each side)
Depth into garage:	for doors up to 2125 mm high: 3200 mm for doors up to 3000 mm high: 4125 mm

Clear passage height for doors with GaraMatic operator:
for doors up to 3000 mm wide:
garage door height - 30 mm
for doors wider than 3000 mm:
garage door height - 80 mm

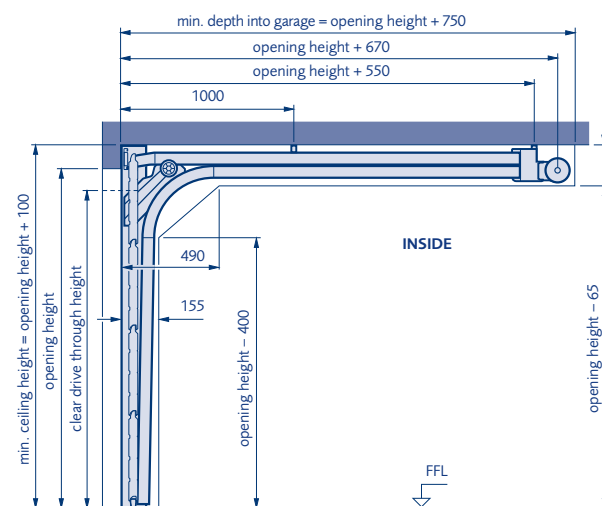

Side view

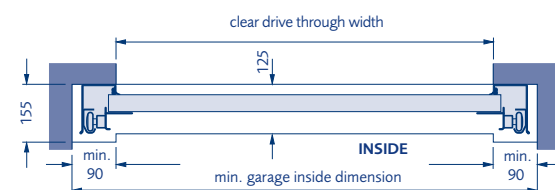

Plan view

Electric Operators

Safety – in compliance with the latest European standards

Security – integral anti-burglar device

Convenience – super-smooth and maintenance-free



BS 13241 Compliant
The combination of Garador garage doors with GaraMatic operators complies with the latest European safety standards.

All operators come as a complete set as standard, including operator head, operator rail and two hand transmitters (one 4-channel hand transmitter and one 2-channel micro hand transmitter). All operators perfectly match Garador garage doors and can also be fitted to doors of other makes.

GaraMatic 10 GaraMatic 20

Peak forces

GaraMatic 10: 800 N

GaraMatic 20: 1000 N

- 50% faster than other operators
- Half-open function for ventilation
- Adjustable soft start and soft stop
- Automatic safety reversal
- Adjustable integral halogen light
- Self-closing timer option (light beam device required)
- GaraMatic 20 comes complete with Light Beam Device as standard



Article	GARAMATIC 10 CANOPY DOORS *	GARAMATIC 10 RETRACTABLE DOORS & SECTIONAL DOORS	GARAMATIC 10 SECTIONAL DOORS over 2125 mm	GARAMATIC 20 CANOPY DOORS *	GARAMATIC 20 RETRACTABLE DOORS & SECTIONAL DOORS	GARAMATIC 20 SECTIONAL DOORS over 2125 mm
Price	£ 513	£ 440	£ 552	£ 574	£ 503	£ 613

* Canopy door price includes canopy bow arm system.

GaraMatic 7 GaraMatic 9

Peak forces

GaraMatic 7: 650 N

GaraMatic 9: 750 N

- Simple to operate
- Soft start and soft stop
- Automatic safety reversal
- Integral light
- Streamlined plastic cover

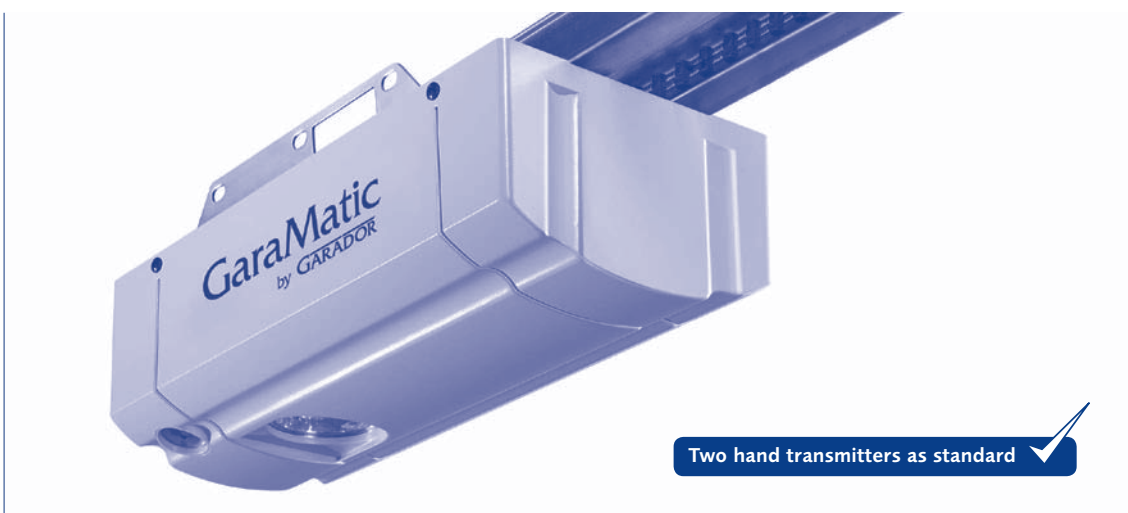

Article	GARAMATIC 7 CANOPY DOORS *	GARAMATIC 7 RETRACTABLE DOORS & SECTIONAL DOORS	GARAMATIC 7 SECTIONAL DOORS over 2125 mm	GARAMATIC 9 CANOPY DOORS *	GARAMATIC 9 RETRACTABLE DOORS & SECTIONAL DOORS	GARAMATIC 9 SECTIONAL DOORS over 2125 mm
Price	£ 436	£ 364	£ 474	£ 492	£ 421	£ 533

* Canopy door price includes canopy bow arm system.

Accessories for Electric Operators

Accessories

						
Article	HAND TRANSMITTER, 4-CHANNEL	HAND TRANSMITTER MICRO, 2-CHANNEL	HAND TRANSMITTER MINI, 4-CHANNEL	WIRELESS CODE SWITCH WITH LID, ILLUMINATED	WALL CONSOLE	WIRELESS WALL CONSOLE
Reference No.	680	683	682	2872	2873	2874
Price	£ 48	£ 48	£ 48	£ 74	£ 29	£ 46

Accessories

Article
Reference No.
Price

Boom for canopy door including canopy bow arm

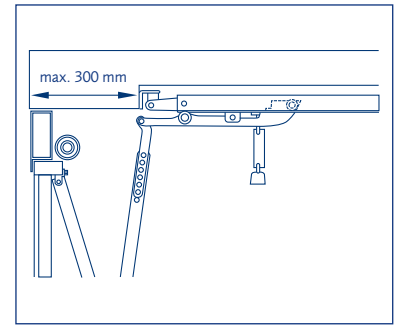
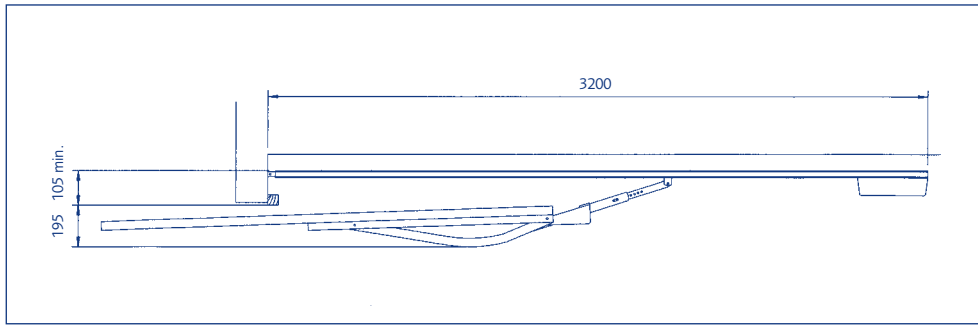

Lintel extension bracket required for canopy doors fitted between the brickwork and under the lintel head.

Boom for retractable door

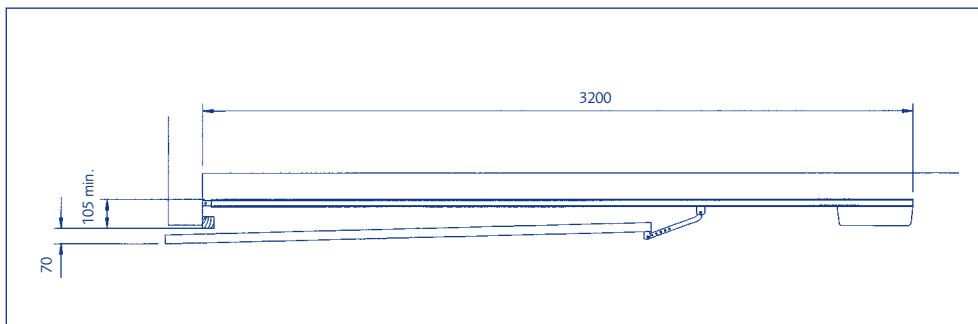

Boom for sectional door

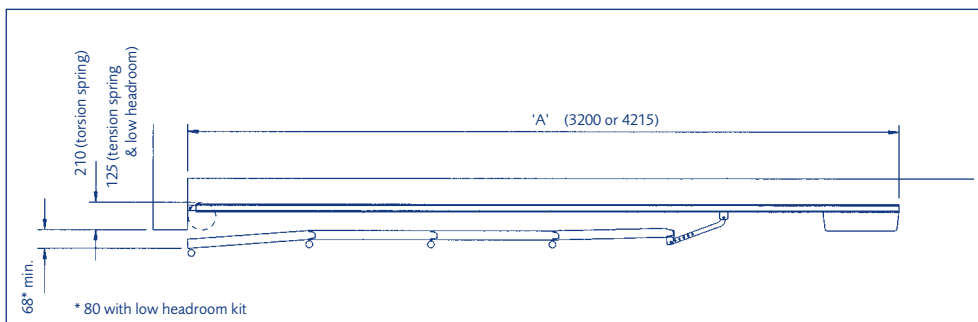

A Garador garage door needs only a minimum level of preparation and maintenance to give years of trouble-free service. Below is a guide to how to get the best from your garage door.

Operation

- For opening the door in manual operation use only the outside handle or inside handle. Never use the pull rope during the opening cycle of the door.
- For closing the door from the outside – the pull rope fixed to the internal handle is only designed to pull the door towards you whilst standing within the entrance of the garage until the door can be pushed down by hand, then using the external handle for final closing.
- For closing the door from the inside – the pull rope already mentioned is designed to be pulled away from you, when facing the front entrance of the garage, until the internal handle is able to be reached, by hand, and used for final closing. The pull rope is not designed to be used for any other part of the operating cycle, or any other purpose. Failure to comply with the above instructions may result in injury to persons or property.
- When the door is operated from either outside or inside, check the area through which the door will travel is clear from people and objects. Failure to do so may result in injury to persons or property.
- When closing, ensure the latches engage properly.
- If the door is power-operated always try to ensure you match the door with a Garador electric operator to ensure full compliance with the Machinery Directive. If another make must be used always consider any compatibility/compliance issues.

Cleaning

- The door, and frame if applicable, should be washed with a mild soap-based solution on a regular basis to prevent the build up of dirt, salts and other corrosive substances and help maintain the aesthetic appearance of the product.
- If the door is installed in a seafront location, the door panel and frame should be cleaned in this way at least every two months.
- We also suggest that all other components be brushed down on a regular basis to prevent the build up of dirt and dust etc.

Locking

- If the key is turned completely, the door is then locked or unlocked; when unlocked it is then possible to open and close the door by turning the handle.
- If the key is turned 1/4 of the way, the door opened and then the key returned to its start position, the door will re-lock when closed.
- By moving the internal locking "snib", it is possible to lock and unlock the door from the inside without using the key.

Maintenance

- If in doubt about any of these maintenance procedures below always consult a Garador specialist. Garador Ltd. has a nationwide network of installers who will be able to offer you a regular maintenance service on your garage door. Please call Garador or refer to the Garador website for further details of your nearest installer.
- Immediately after the door is fitted and after every 5,000 operations of the door, or at least once a year, oil all pivot points, check screws and clamped connections for tightness, keep the running tracks clean (do not grease them), check parts and replace any worn components where necessary.
- The springs should be replaced after approx. 25,000 operations by an experienced door fitter (see fitting and operation instructions).
- Do not oil the lock cylinder; if it is sticking, only lubricate with graphite dust.
- For canopy doors only, check the cable every 6 months with normal usage (8 operations per day). Have the cables replaced by an expert if any wear is found.

Finish – Steel Doors

The coating process applied to the door and chassis is environmentally friendly. Minor scratches or marks are not covered under the conditions of our warranty and should be repaired immediately to prevent corrosion and deterioration of the panel. Corrosive such as acids, alkalines, and salts, etc. should be cleaned from the door immediately; failure to do so will result in deterioration of the finish, which will not be covered under our warranty. If you choose to paint your powder coated door then prepare the surface lightly with wet and dry. Then treat with two coats of a normal commercial paint for external use (cellulose paints must not be used).

Finish – Timber Doors

Timber doors are supplied poly-wrapped, and the timber panels coated with a neutralising base-stain (except Cavendish, which is supplied untreated). Doors must be stored upright, under cover, with wrapping intact, until wrapping is removed. As soon as the door is unwrapped, one coat of a good quality basecoat primer must be applied to both sides of the door. Immediately after installation, your timber doors require a further two coats of a good quality exterior wood finish on both sides. Initial application and periodic treatment should be carried out strictly in accordance with the woodstain manufacturer's instructions. Failure to follow these instructions will result in early deterioration of the timber panel.

Finish – GRP Doors

GRP door panels should periodically washed down using water. This should be done more frequently if fitted near the sea. Bird droppings will bleach the finish on GRP, and should be removed using water as soon as possible. GRP doors should not be painted over.

Paint Finish – Steel Doors

Garador steel doors are a finished product. They do not require re-painting on site. They are however not immune to damage, which can occur at any stage of the handling of the product from factory to site. Minor surface damage can easily be repaired using touch up sprays or sticks without invalidating warranties. For extra peace of mind, order your steel door poly-wrapped at the factory to help prevent damage from occurring prior to installation.

Warranty

Garador products are manufactured to the highest quality standards and leave our factory only after rigorous quality testing. However, if you should have grounds for complaint, this section tells you what our door warranty offers, and how to go about making your claim.

In the unlikely event of a warranty claim becoming necessary, please contact the dealer or distributor who originally supplied your garage door. Your dealer should then supply details of the claim, together with a copy of the warranty card provided with the door and proof of purchase to the Warranty Department at Garador Ltd.

To enable your claim under warranty to be processed as quickly as possible, you should provide the following details:

- 1 Your name, address and telephone number
- 2 Original invoice with date of purchase
- 3 Product description/door type and product number
- 4 Description of defect

An assessment of the claim will then be made. This may require Garador to inspect the product in-situ. In the event that there is no legitimate warranty claim under the terms specified herein, you may be liable for the costs of the inspection visit. We strongly recommend that you take note of the care and usage instructions displayed on the stickers on the back of your garage door, and on the page opposite, and that you follow these instructions throughout.

Garador installers Garador Ltd. has a nationwide network of recommended installers who will be able to offer you a regular maintenance service on your garage door. Please call us on 0800 706670 or refer to the Garador website for further details of your nearest installer.

Garador Garage Door Warranty

- Warranty Period** The purchaser is granted a warranty covering the safe and reliable function of the Garador garage door for a period of 10 years from the date of purchase. The warranty period for replacement parts is 6 months or to the end of the current warranty period, whichever is longer.
- In the case of foil-coated timber-effect and PVC doors, a warranty of 5 years is granted, for timber and GRP doors a warranty of 2 years is granted on the door panels alone under the terms and conditions specified herein. The door mechanism and steel frame (if applicable) is covered by the 10 year warranty period.
- Requirements** Warranty claims are only applicable in the country where the garage door was purchased. The product must have been purchased through our authorised distribution channels. The warranty only covers damage to the contract object. The fully completed warranty card together with the receipt of purchase correspondingly dated substantiates your right to claim under the warranty.
- Performance** During the warranty period we undertake to rectify any and all defects to the Garador product which can be proved to be attributed to a material or manufacturing fault. We pledge at our discretion either to exchange the defective merchandise for faultless merchandise, repair it or allow a reduction in price. We do not accept costs for dismantling and installation nor for carriage. Replaced parts become our property.
- The warranty does not cover damage caused through:
- normal wear and tear
 - improper installation
 - negligent care and maintenance
 - improper initial and subsequent operation
 - negligent or wanton destruction
 - external influences such as fire, water, salts, alkaline solutions, acids, abnormal environmental influences
 - mechanical damage through improper transport and fitting
 - priming and other surface protection treatments
 - incorrect or too late applied surface protection treatments
 - repair by non-qualified persons
 - using non-Garador parts without the approval of the manufacturer
 - remove of the product number or making it unidentifiable
- Electric Operator Warranty** A separate 5 year warranty is granted on our electric operators. This includes operator mechanics, motor and motor control systems. A 2 year warranty is granted on radio equipment, accessories and system controls. There is no warranty on consumables (e. g. fuses, batteries, bulbs etc.). For further details please contact us on 0800 706670, or through our website on www.garador.co.uk

Extracts from AGDS consumer advice

The following document was designed by the Association of Garage Door Specialists and endorsed by all major UK garage door manufacturers, as a guide for purchasers of domestic garage doors.

VISUAL APPEARANCE OF GARAGE DOORS

A new garage door can be a significant investment that will transform the appearance of your home. This information is a guide to the quality you can expect.

THE QUALITY CHECK

The quality check should be carried out in natural daylight, not direct sunlight. Stand at a distance of 3 metres from the door to view the overall appearance.

The door is acceptable if, taking into account the facts below, none of the following are readily visible on the face of the door:

- Marks or distortion associated with the manufacturing process
- Minor indentations, marks or scuffs on the surface
- Paint or stain blemishes

THE FACTS

STEEL DOORS

Panel Distortion The rolling or pressing of steel panels during manufacture will cause distortion in the steel and while every effort is made to keep this to a minimum, inevitably some visible distortion will remain. The application of high gloss paints will make this slight distortion more apparent, especially under certain lighting conditions, such as car headlamps, or bright sunshine.

Paint Finish Primed doors – the primer coating is applied as a base coat only and as such requires additional finishing with a good quality exterior paint. Any marks or scratches on the primer coat should be rubbed down and repainted as part of this finishing process.

Finished doors – the factory application of the paint finish is an automated process and this may result in minor blemishes or slight inconsistencies in the paint, particularly in the area of panel joints.

TIMBER DOORS

Timber Timber is a natural product and there will be variations in pattern, colour, shading and grains. No two doors will be the same. Because wood naturally expands and contracts according to environmental conditions, joints will open and close and some minor curvature may occur.

Finishing It is vital that timber doors are fully finished as per the manufacturers instructions before exposure to the elements.

GRP AND COMPOSITE PLASTIC DOORS

Mould Marks GRP doors are individually handcrafted in a mould and are then hand finished. Some minor marks and blemishes will inevitably remain after this process.

Translucency When viewed from the inside, it is often possible to see variations in the translucency of the door, particularly around and between areas of relief. Such variations do not detract from the overall strength or build quality of the door.

ALL DOORS

Colour Match Pairs of doors should be ordered together to obtain the best colour match, bearing in mind the limitations of the materials used in the construction. Timber garage doors cannot be ordered as matching sets.

Size Variations As the size of a door changes in height and/or width, the panel frequency and profile can change, therefore doors of the same style but of different sizes can be significantly different in appearance.

Clearances All doors require operating clearances, i.e. the gap between the door panel and the frame opening, these are inbuilt during manufacture and should not be reduced by means of infills, or draughtproofing.

Deflection When in the open position, all doors will display a level of vertical deflection or 'sag' across the width of the panel. Individual manufacturers' specifications should be consulted for exact tolerances.



This page is reproduced with the kind permission of the Association of Garage Door Specialists. For further details on the AGDS, go to www.agds.co.uk.

Since the company's policy is one of continuous improvement of its products, we reserve the right to make any alterations in design, manufacture or price. All business is governed by the company's Standard Conditions and this document does not form any part of any contract with the company and statements contained in it should not be construed as representations or warranties.

GARADOR

Bunford Lane, Yeovil, Somerset, BA20 2EJ
Tel: (01935) 443722 Fax: (01935) 443744

www.garador.co.uk

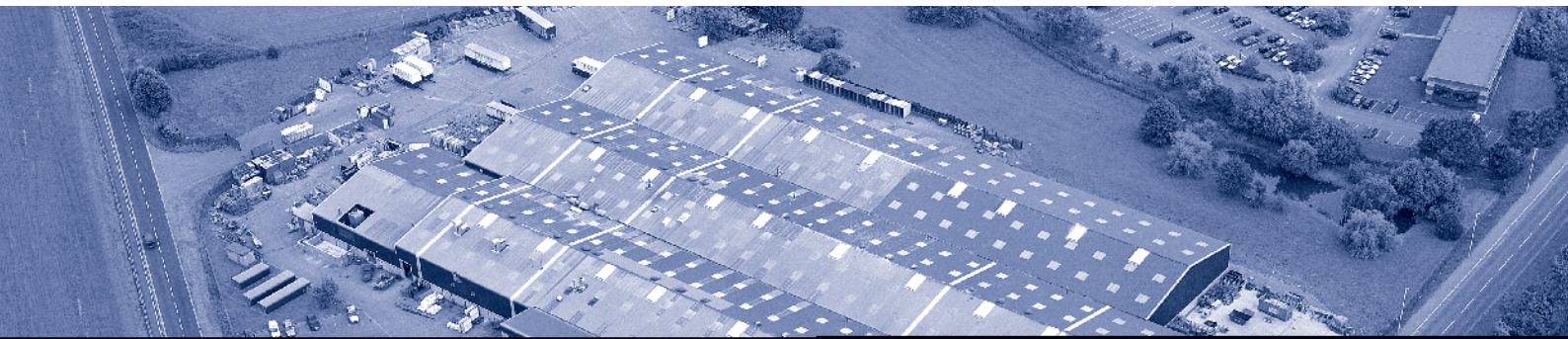

Garador Ltd, located in Yeovil, Somerset, has the most advanced up & over door production facility in the industry. Manufacturing to the highest level of quality and reliability we offer a complete range of garage doors and operators.